



// ONE BRAND // ONE SOURCE // ONE SYSTEM



// SERVICE // MATERIAL PROCESSING // SURFACE PROTECTION // AUTOMOTIVE

REMA TIP TOP

Product Portfolio – Material Processing 2016/2017





// ONE BRAND // ONE SOURCE // ONE SYSTEM

Editor

REMA TIP TOP AG

Gruber Strasse 65 · 85586 Poing / Germany

Phone: +49 8121 707-0

Fax: +49 8121 707-10 222

info@tiptop.de

www.rema-tiptop.com

Legal Notice

Copyright © 2016 REMA TIP TOP AG

All information is given to the best of our knowledge. All specifications are to be considered non-binding information. Any claim for damages of any kind is excluded. We reserve the right to change technical specifications without prior notice, provided that they ensure product improvement. The information presented is based on technical experience but does not guarantee a product's suitability for specific applications, and does not relieve the users of the responsibility to undertake their own testing, including where any third-party trademark rights are concerned. For special applications and operating conditions with regard to temperature, UV light, ozone, acids and alkaline solutions, dynamic and static forces, tensions, elongations and other influences, contact your local REMA TIP TOP distributor for technical advice.

Operating and working instructions, product information and general instructions on the vulcanization properties of natural and synthetic rubber should be followed carefully. The mechanical and physical values presented for our products only apply to the material listed (without bonding layer and without fabric) based on the accompanying inspections for approval; these represent statistical product data, but not guaranteed product properties. Detailed technical data sheets for each single product are available upon request. The weight indications (kg/m², kg/m, etc.) solely represent statistical values and are not necessarily identical to the actual weights.



The weights indicated are merely guidelines for the handling, transport and application of our products. The dimension tolerances are based on part 5 of DIN 7715, classification P3 (admissible dimension tolerances for sheets) and DIN ISO 3302-1, classification M4 (molded parts made of soft-rubber). Other tolerances of specific products for special applications are subject to a mutual agreement and must be stipulated in a special contract. Products containing hazardous substances are labeled in accordance with the regulations (EG) No. 1907/2006 for the classification, packaging and labeling of hazardous materials and preparations.

In order to preserve product properties, the storage conditions indicated in DIN 7716 should be followed (including storing the product in the original package and in an area that is dry, cool and dark).

Products printed in bold are normally available from stock.



Wear Protection

Wear Protection Lining	5-36
Heavy Wear Protection	37-52
Anticaking	53-56
Adhesives and Rubber Solutions	57-74

Conveying Solutions

Pulley Lagging	75-100
Feeding Systems	101-106
Skirting	107-114
Rollers / Idlers	115-120
Belt Cleaning Systems	121-182
Conveyor cover systems	183-186

Mineral Processing

Mill lining	187-190
Material handling hose systems	191-194

Conveyor belting

Cleats and Sidewalls	195-198
Conveyor belting	199-202
Cold Splicing and Repair Material	203-210
Hot Splicing and Repair Material	211-220
WK Splicing and Repair Material	221-224
Mechanical Splicing and Repair Material	225-236

Annex

Questionnaire	237-251
Index	252-257

REMA TIP TOP means quality, service and innovative solutions in all sectors of business:

ONE BRAND – ONE SOURCE – ONE SYSTEM

// AUTOMOTIVE

As a professional supplier of system solutions, REMA TIP TOP offers its partners in the automotive sector a unique and comprehensive range of products and services.



// MATERIAL PROCESSING

The use of specific REMA TIP TOP products lengthens the service life of conveying and processing plant and reduces downtime.



// SURFACE PROTECTION

Our corrosion protection systems prevent damage and maintain the value of your plant while contributing to environmental protection.



// SERVICE

REMA TIP TOP customers have relied on individual all-in care and support by our highly-qualified specialists for decades.



Solutions

- Agriculture
- Car workshops, car service
- Cement industry
- Chemical industry
- Building industry
- Container & plant construction
- Energy industry
- Foodstuffs industry
- Foundries
- Goods transport
- Metalworking and machine building
- Mining and mines
- Recycling industry
- Retail trade (cycles/motorcycles)
- Tyre retreading
- Gravel, sand and stone breaking mills
- Transport, logistics and haulage operations
- Tyre trade, tyre service
- Water management

WEAR PROTECTION LINING



REMA TIP TOP



REMA LINE – High-quality rubber lining material	6-27
REMA STAR – High wear-resistance TPU lining material	28
UNILINE – Rubber lining material for simple applications	29-30
REMA THAN – High-quality polyurethane lining material	31-36

WEAR PROTECTION LINING

REMALINE – High-quality rubber lining material

REMALINE 25 – The safe protection against wear and material build-up

Due to its elastic properties, REMALINE 25 lining is suitable for preventing build-up in equipment conveying sand/water mixtures and fine material. Furthermore, REMALINE 25 lining offers excellent noise dampening and reduction of noise emissions.



REMALINE 25

Properties

- Safe protection against wear and material build-up
- Highly elastic and flexible
- Noise damping
- Wear-resistant (round grains)
- CN bonding layer provides fast and long-lasting adhesion

Area of application

- Covers for conveyor rollers
- Lining of elevator buckets and excavator buckets
- Outlet funnels for dry mortar
- Flexilo and bunker lining
- Noise reduction lining

REMALINE 25/CN

Specifications

Polymer basis	NR/IR	DIN ISO 1629
Specific weight	0.97 g/cm ³	DIN EN ISO 1183-1
Hardness	33 Shore A	DIN ISO 7619-1
Colour	Black	

Ref. No.	Designation	Dimensions	Weight
549 9025	REMALINE 25/CN	3x1500x10 000 mm	3.09 kg/m ²
549 9000	REMALINE 25/CN	6x2000x10 000 mm	6.62 kg/m ²
549 4240	REMALINE 25/CN	10x2000x10 000 mm	11.20 kg/m ²
549 4288	REMALINE 25/CN	15x2000x10 000 mm	16.20 kg/m ²

WEAR PROTECTION LINING

REMALINE – High-quality rubber lining material

REMALINE 35 – Premium quality for wet wear and build-up

REMALINE 35 features excellent resistance to wet abrasive and sharp particles. The properties of REMALINE 35 make it the optimum rubber lining for sand and gravel industry equipment as well as in the glass industry. REMALINE 35 lining has also proven valuable with sticky material such as loam and clay.

Properties

- Highly wear-resistant, especially resistant to wet abrasion
- Safe protection against material build-up
- Highly elastic
- Excellent self-cleaning capability
- CN bonding layer provides fast and long-lasting adhesion

Area of application

- Slurry handling
- Lining of slurry chutes, pipes, pumps, hydrocyclones, flotation cells, tanks and launders for example in the sand and gravel industry
- Chutes / discharge hoses for ready-mixed concrete
- Lining of excavator buckets to prevent caking



REMALINE 35

REMALINE 35/CN

Specifications

Polymer basis	NR	DIN ISO 1629
Specific weight	0.96 g/cm ³	DIN EN ISO 1183-1
Hardness	33 Shore A	DIN ISO 7619-1
Colour	Yellow*	

Ref. No.	Designation	Dimensions	Weight
549 0347	REMALINE 35/CN	3 x 1500 x 10 000 mm	3.66 kg/m ²
549 9220	REMALINE 35/CN	5 x 2000 x 10 000 mm	5.46 kg/m ²
549 0402	REMALINE 35/CN	6 x 2000 x 10 000 mm	6.90 kg/m ²
549 0440	REMALINE 35/CN	8 x 2000 x 10 000 mm	8.96 kg/m ²
549 0464	REMALINE 35/CN	10 x 2000 x 10 000 mm	11.00 kg/m ²
549 0488	REMALINE 35/CN	12 x 2000 x 10 000 mm	12.96 kg/m ²
549 0505	REMALINE 35/CN	15 x 2000 x 10 000 mm	16.20 kg/m ²
549 0529	REMALINE 35/CN	20 x 2000 x 10 000 mm	21.60 kg/m ²
549 0536	REMALINE 35/CN	25 x 2000 x 10 000 mm	26.50 kg/m ²

* (Please note that this is a product based on natural rubber and therefore deviations in colour may occur.)

WEAR PROTECTION LINING

REMALINE – High-quality rubber lining material

REMALINE 35/EP160 – The fabric reinforced premium quality for wet wear and build-up

REMALINE 35 features excellent resistance to wet abrasive and sharp particles. The properties of REMALINE 35 make it the optimum rubber lining for sand and gravel industry equipment as well as in the glass industry. REMALINE 35 lining has also proven valuable with sticky material such as loam and clay.

Properties

- REMALINE 35 premium quality with fabric reinforcement
- Highly wear-resistant; especially resistant to wet abrasion
- Safe protection against material build-up
- Highly elastic
- Excellent self-cleaning capability
- CN bonding layer provides fast and long-lasting adhesion

Area of application

- Slurry handling
- Lining of slurry chutes, pipes, pumps, hydrocyclones, flotation cells, tanks and launders for example in the sand and gravel industry
- Chutes / discharge hoses for ready-mixed concrete
- Lining of excavator buckets to prevent caking



REMALINE 35

REMALINE 35/EP160/CN

Specifications

Polymer basis	NR	DIN ISO 1629
Specific weight	0.96 g/cm ³	DIN EN ISO 1183-1
Hardness	33 Shore A	DIN ISO 7619-1
Colour	Yellow*	

Ref. No.	Designation	Dimensions	Weight
549 0615	REMALINE 35/EP160/CN	6x2000x10 000 mm	7.08 kg/m ²
549 0653	REMALINE 35/EP160/CN	10x2000x10 000 mm	11.40 kg/m ²
549 0677	REMALINE 35/EP160/CN	12x2000x10 000 mm	13.44 kg/m ²
549 0691	REMALINE 35/EP160/CN	15x2000x10 000 mm	16.50 kg/m ²

* (Please note that this is a product based on natural rubber and therefore deviations in colour may occur.)

WEAR PROTECTION LINING

REMALINE – High-quality rubber lining material

REMALINE MP 35 – The perfect way to reliable production planning

REMALINE MP 35 (Maintenance Pro) puts an end to premature, unplanned system downtime and unnecessary maintenance and standstill costs. This new development, which points the way to the future of lining materials, offers more than just first-class surface protection. It also gives you a timely reminder when the lining needs to be renewed. Thus, you can easily plan and schedule to ensure smooth-running production processes, and significantly increased system productivity. A unique advantage, particularly where it is difficult to check the thickness of the lining using conventional methods.



REMALINE MP 35

Properties

- Safe protection against wear and material build-up with built-in wear indicator
- Yellow wear layer
- Red signal layer
- Highly wear-resistant, particularly for wet use
- Very elastic
- High self-cleaning effect
- Noise damping; reduces dust formation
- CN bonding layer provides fast and long-lasting adhesion

Area of application

- Especially suitable for conveying components that are hard to access and inspect using conventional methods
- Lining of drains, pipes, hydrocyclones, flotation cells, tanks, etc for example in the sand and gravel industry
- Slurry handling
- Flexilo and bunker lining
- Lining of excavator buckets to prevent caking

REMALINE MP 35/CN

Specifications

Polymer basis	NR	DIN ISO 1629
Specific weight	0.96 g/cm ³	DIN EN ISO 1183-1
Hardness	33 Shore A	DIN ISO 7619-1
Colour	Red/Yellow*	

Ref. No.	Designation	Dimensions	Signal layer	Weight
549 1710	REMALINE MP 35/CN	6(4) x 2000 x 10 000 mm	2 mm	6.9 kg/m ²
549 1720	REMALINE MP 35/CN	10(6) x 2000 x 10 000 mm	4 mm	11,00 kg/m ²
549 1730	REMALINE MP 35/CN	12(8) x 2000 x 10 000 mm	4 mm	12.96 kg/m ²
549 1740	REMALINE MP 35/CN	15(11) x 2000 x 10 000 mm	4 mm	16.20 kg/m ²
549 1750	REMALINE MP 35/CN	20(16) x 2000 x 10 000 mm	4 mm	21.60 kg/m ²

* (Please note that this is a product based on natural rubber and therefore deviations in colour may occur.)

WEAR PROTECTION LINING

REMALINE – High-quality rubber lining material

REMALINE 40 – The universal lining for many applications

REMALINE 40 has been designed for a variety of wet or dry applications. In dry applications, REMALINE 40 is frequently used for conveying coke. In wet applications, this material has proven its outstanding value as a protective coating for sharp particles due to its high resistance to tearing. REMALINE 40 also features excellent qualities for eliminating bridge formation and build-up.



REMALINE 40

Properties

- Safe protection against wear and material build-up especially for sharp-edged material
- High tensile strength
- High tear growth resistance
- Highly elastic
- CN bonding layer provides fast and long-lasting adhesion

Area of application

- Universally applicable as lining against caking, abrasion and impact
- Flexilo and hopper lining
- Lining for coal processing
- Lagging for non-driven pulleys with low belt tension (build-up protection)

REMALINE 40/CN

Specifications

Polymer basis	NR	DIN ISO 1629
Specific weight	1.05 g/cm ³	DIN EN ISO 1183-1
Hardness	50 Shore A	DIN ISO 7619-1
Colour	Black	

Ref. No.	Designation	Dimensions	Weight
549 0914	REMALINE 40/CN	3 x 1500 x 10 000 mm	3.96 kg/m ²
549 0976	REMALINE 40/CN	6 x 2000 x 10 000 mm	6.93 kg/m ²
549 0990	REMALINE 40/CN	10 x 2000 x 10 000 mm	11.50 kg/m ²
549 1030	REMALINE 40/CN	15 x 2000 x 10 000 mm	16.95 kg/m ²
549 1054	REMALINE 40/CN	20 x 2000 x 10 000 mm	22.40 kg/m ²
549 1092	REMALINE 40/CN	25 x 2000 x 10 000 mm	28.00 kg/m ²

WEAR PROTECTION LINING REMALINE – High-quality rubber lining material

REMALINE 40 ORANGE – The universal lining for many applications especially from wet abrasion

REMALINE 40 ORANGE has been designed to withstand wear and caking, especially from wet abrasion, for a variety of applications.

Properties

- Safe protection against wear and material build-up especially from wet abrasion
- Highly elastic
- Good self-cleaning capability
- CN bonding layer provides fast and long-lasting adhesion

Area of application

- Universally applicable as lining of, for example, slurry chutes, pipes, flotation cells, tanks and launders
- Flexilo and hopper lining
- Lining for coal processing
- Lining of excavator buckets to prevent caking
- Slurry handling



REMALINE 40 ORANGE

REMALINE 40 ORANGE/CN

Specifications

Polymer basis	NR	DIN ISO 1629
Specific weight	1.05 g/cm ³	DIN EN ISO 1183-1
Hardness	44 Shore A	DIN ISO 7619-1
Colour	Orange*	

Ref. No.	Designation	Dimensions	Weight
549 0873	REMALINE 40 ORANGE/CN	3x1500x10 000 mm	3.59 kg/m ²
549 0859	REMALINE 40 ORANGE/CN	6x2000x10 000 mm	6.80 kg/m ²
549 0804	REMALINE 40 ORANGE/CN	10x2000x10 000 mm	11.13 kg/m ²
549 0811	REMALINE 40 ORANGE/CN	12x2000x10 000 mm	13.23 kg/m ²
549 0828	REMALINE 40 ORANGE/CN	20x2000x10 000 mm	21.84 kg/m ²
549 0835	REMALINE 40 ORANGE/CN	25x2000x10 000 mm	27.04 kg/m ²

* (Please note that this is a product based on natural rubber and therefore deviations in colour may occur.)

WEAR PROTECTION LINING

REMALINE – High-quality rubber lining material

REMALINE 40/EP160 – The fabric reinforced universal lining for many applications

REMALINE 40/EP160 has been specially designed to withstand wear and caking for a variety of wet or dry applications in challenging operating conditions.

Properties

- REMALINE 40 premium quality with fabric reinforcement
- Safe protection against wear and material build-up, especially from wet abrasion
- Highly elastic
- Good self-cleaning capability
- CN bonding layer provides fast and long-lasting adhesion

Area of application

- Universally applicable as lining against caking, abrasion and impact
- Flexilo and hopper lining
- Lining for coal processing
- Lining of excavator buckets to prevent caking



REMALINE 40/EP

REMALINE 40/EP160/CN

Specifications

Polymer basis	NR	DIN ISO 1629
Specific weight	1.05 g/cm ³	DIN EN ISO 1183-1
Hardness	50 Shore A	DIN ISO 7619-1
Colour	Black	

Ref. No.	Designation	Dimensions	Weight
549 1140	REMALINE 40/EP160/CN	6 x 2000 x 10 000 mm	6.93 kg/m ²
549 1229	REMALINE 40/EP160/CN	10 x 2000 x 10 000 mm	11.60 kg/m ²
549 1236	REMALINE 40/EP160/CN	15 x 2000 x 10 000 mm	17.10 kg/m ²

WEAR PROTECTION LINING

REMALINE – High-quality rubber lining material

REMALINE 40 OIL – The oil and grease resistant universal lining for many applications

REMALINE 40 OIL has been designed for a variety of wet or dry applications in which oil and grease are or might be involved.

Properties

- Oil and grease resistant REMALINE 40 premium quality
- Safe protection against wear and material build-up especially from wet abrasion
- Highly elastic
- Good self-cleaning capability
- CN bonding layer provides fast and long-lasting adhesion

Area of application

- Universally applicable as lining against caking, abrasion and impact
- Flexilo and hopper lining
- Lining for coal processing
- Lagging for non-driven pulleys with low belt tension (build-up protection)
- Lining to prevent caking



REMALINE 40 OIL

REMALINE 40 OIL/CN

Specifications

Polymer basis	NBR	DIN ISO 1629
Specific weight	1.09 g/cm ³	DIN EN ISO 1183-1
Hardness	44 Shore A	DIN ISO 7619-1
Colour	Black	

Ref. No.	Designation	Dimensions	Weight
549 1267	REMALINE 40 OIL/CN	3x1500x10 000 mm	3.60 kg/m ²
549 1300	REMALINE 40 OIL/CN	6x2000x10 000 mm	7.25 kg/m ²
549 1410	REMALINE 40 OIL/CN	10x2000x10 000 mm	12.00 kg/m ²

WEAR PROTECTION LINING

REMALINE – High-quality rubber lining material

REMALINE 40 WHITE FOOD – The universal lining for food contact

REMALINE 40 WHITE FOOD has been designed for a variety of wet or dry applications. It fulfills the requirements for food contact and can be safely applied in any systems with hygiene requirements in accordance with:

- Federal Institute for Risk Assessment, Recommendations on Food Contact Materials XXI, Cat. 3+4 (Germany)
- Regulation (EU) No. 1935/2004
- FDA Regulation No. 21 CFR 177.2600

Properties

- Food quality
- Safe protection against wear and material build-up
- Highly elastic
- Good self-cleaning capability
- CN bonding layer provides fast and long-lasting adhesion

Area of application

- Special lining for the food industry
- Universally applicable as lining against caking, abrasion and impact
- Flexilo and hopper lining
- Lining to prevent caking



REMALINE 40 WHITE FOOD

REMALINE 40 WHITE FOOD/CN

Specifications

Polymer basis	NR/BR	DIN ISO 1629
Specific weight	1.02 g/cm ³	DIN EN ISO 1183-1
Hardness	39 Shore A	DIN ISO 7619-1
Colour	White*	

Ref. No.	Designation	Dimensions	Weight
549 2490	REMALINE 40 WHITE FOOD/CN	3x1200x10 000 mm	3.40 kg/m ²
549 2470	REMALINE 40 WHITE FOOD/CN	6x2000x10 000 mm	6.80 kg/m ²
549 9070	REMALINE 40 WHITE FOOD/CN	10x2000x10 000 mm	11.40 kg/m ²

* (Please note that this is a product based on natural rubber and therefore deviations in colour may occur.)

WEAR PROTECTION LINING

REMALINE – High-quality rubber lining material

REMALINE MP 40 – The perfect way to reliable production planning

REMALINE MP 40 (Maintenance Pro) puts an end to premature, unplanned system downtime and unnecessary maintenance and standstill costs. This new development, which points the way to the future of lining materials, offers you more than just first-class surface protection. It also gives you a timely reminder when the lining needs to be renewed. Thus, you can easily plan and schedule to ensure smooth-running production processes, and significantly increased system productivity. A unique advantage, particularly where it is difficult to check the thickness of the lining using conventional methods.

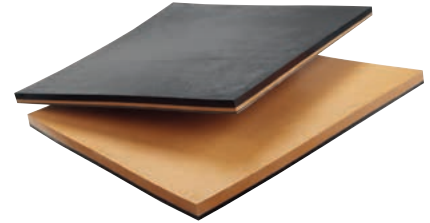

REMALINE MP 40

Properties

- Safe protection against wear and material build-up with built-in wear indicator
- Orange wear layer
- Black signal layer
- Highly wear-resistant, particularly for wet use
- Very elastic
- High self-cleaning effect
- Noise damping; reduces dust formation

- CN bonding layer provides fast and long-lasting adhesion

Area of application

- Especially suitable for conveying components that are hard to access and inspect using conventional methods
- Lining of drains, pipes, hydrocyclones, flotation cells, tanks, etc for example in the sand and gravel industry
- Slurry handling

- Flexilo and bunker lining
- Lining of excavator buckets to prevent caking
- Lagging for non-driven pulleys with low belt tension (build-up protection)

REMALINE MP 40/CN

Specifications

Polymer basis	NR	DIN ISO 1629
Specific weight	1.05 g/cm ³	DIN EN ISO 1183-1
Hardness	44 Shore A	DIN ISO 7619-1
Colour	Black/Orange*	

Ref. No.	Designation	Dimensions	Signal layer	Weight
549 1630	REMALINE MP 40/CN	6(4) x 2000 x 10 000 mm	2 mm	6.80 kg/m ²
549 1631	REMALINE MP 40/CN	8(6) x 2000 x 10 000 mm	2 mm	9.15 kg/m ²
549 1632	REMALINE MP 40/CN	10(6) x 2000 x 10 000 mm	4 mm	11.13 kg/m ²
549 1633	REMALINE MP 40/CN	12(8) x 2000 x 10 000 mm	4 mm	13.23 kg/m ²
549 1634	REMALINE MP 40/CN	15(11) x 2000 x 10 000 mm	4 mm	16.85 kg/m ²
549 1635	REMALINE MP 40/CN	20(16) x 2000 x 10 000 mm	4 mm	21.84 kg/m ²
549 1636	REMALINE MP 40/CN	25(21) x 2000 x 10 000 mm	4 mm	27.04 kg/m ²
549 1490	REMALINE MP 40/CN	50(40) x 2000 x 5000 mm	10 mm	54.08 kg/m ²

* (Please note that this is a product based on natural rubber and therefore deviations in colour may occur.)

WEAR PROTECTION LINING

REMALINE – High-quality rubber lining material

REMALINE 50 – The highly tear-resistant lining

REMALINE 50 is suitable for wet and dry applications due to its unique characteristics. Its great elasticity and high tear resistance make it especially suitable for lining pipes, chutes and tanks in power plants and gravel works. Furthermore, it can be used on non-driven pulleys to prevent build-up.

Properties

- Safe protection against wear and material build-up especially from wet abrasion and sharp-edged material
- High tear growth resistance
- High cut resistance
- CN bonding layer provides fast and long-lasting adhesion

Area of application

- Applications in wet areas such as linings for cool water pipes in power plants
- Lining of chutes, tanks and discharge hoppers for round grains
- Lagging for non-driven pulleys with low belt tension (prevents caking)



REMALINE 50

REMALINE 50/CN

Specifications

Polymer basis	NR	DIN ISO 1629
Specific weight	1.11 g/cm ³	DIN EN ISO 1183-1
Hardness	51 Shore A	DIN ISO 7619-1
Colour	Orange*	

Ref. No.	Designation	Dimensions	Weight
549 2527	REMALINE 50/CN	3x1500x10 000 mm	3.96 kg/m ²
549 9080	REMALINE 50/CN	5x2000x10 000 mm	6.25 kg/m ²
549 2565	REMALINE 50/CN	6x2000x10 000 mm	7.38 kg/m ²
549 2620	REMALINE 50/CN	10x2000x10 000 mm	11.70 kg/m ²
549 2644	REMALINE 50/CN	12x2000x10 000 mm	14.04 kg/m ²
549 2668	REMALINE 50/CN	15x2000x10 000 mm	17.40 kg/m ²
549 2682	REMALINE 50/CN	20x2000x10 000 mm	23.00 kg/m ²

* (Please note that this is a product based on natural rubber and therefore deviations in colour may occur.)

WEAR PROTECTION LINING

REMALINE – High-quality rubber lining material

REMALINE 60 – The lining for protection from impact wear

Due to its low-abrasion properties, REMALINE 60 is especially suitable for protecting against impact and dry wear and, based on this, is frequently used for conveying coal. Furthermore, non-driven pulleys can be lagged with REMALINE 60.

Properties

- Safe protection against wear and material build-up to dry abrasion and impact
- Good weather resistance
- CN bonding layer provides fast and long-lasting adhesion

Area of application

- Lining for vibration chutes, slides, material transfer points, truck bodies, impact curtains, bunkers, silos, chutes and sieve basins
- Lagging for non-driven pulleys with moderate to high belt tension

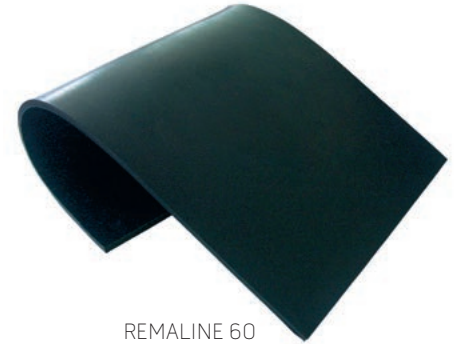

REMALINE 60

REMALINE 60/CN

Specifications

Polymer basis	BR/IR/SBR	DIN ISO 1629
Specific weight	1.13 g/cm ³	DIN EN ISO 1183-1
Hardness	60 Shore A	DIN ISO 7619-1
Colour	Black	

Ref. No.	Designation	Dimensions	Weight
549 2819	REMALINE 60/CN	3x1500x10 000 mm	4.05 kg/m ²
549 3052	REMALINE 60/CN	5x2000x10 000 mm	6.30 kg/m ²
549 2871	REMALINE 60/CN	6x2000x10 000 mm	7.44 kg/m ²
549 2895	REMALINE 60/CN	8x2000x10 000 mm	9.84 kg/m ²
549 2912	REMALINE 60/CN	10x2000x10 000 mm	12.10 kg/m ²
549 2936	REMALINE 60/CN	12x2000x10 000 mm	14.28 kg/m ²
549 2950	REMALINE 60/CN	15x2000x10 000 mm	17.85 kg/m ²
549 2974	REMALINE 60/CN	20x2000x10 000 mm	23.60 kg/m ²
549 2998	REMALINE 60/CN	25x2000x10 000 mm	29.50 kg/m ²
549 3021	REMALINE 60/CN	30x2000x10 000 mm	35.40 kg/m ²
549 3069	REMALINE 60/CN	40x2000x5000 mm	47.20 kg/m ²
549 3083	REMALINE 60/CN	50x2000x5000 mm	59.00 kg/m ²

WEAR PROTECTION LINING REMALINE – High-quality rubber lining material

REMALINE 60/EP160 – The fabric reinforced lining for protection from impact wear

REMALINE 60/EP160 has been specially designed to withstand wear and caking for a variety of wet or dry applications in challenging operating conditions with high impact energies.

Properties

- REMALINE 60 premium quality with fabric reinforcement
- Safe protection against wear and material build-up to dry abrasion and impact
- Good weather resistance
- CN bonding layer provides fast and long-lasting adhesion

Area of application

- Lining for vibration chutes, slides, material transfer points, truck bodies, impact curtains, bunkers, silos, chutes and sieve basins

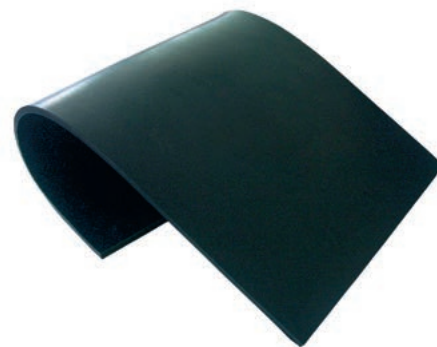

REMALINE 60/EP160/CN

REMALINE 60/EP160/CN

Specifications

Polymer basis	BR/IR/SBR	DIN ISO 1629
Specific weight	1.13 g/cm ³	DIN EN ISO 1183-1
Hardness	60 Shore A	DIN ISO 7619-1
Colour	Black	

Ref. No.	Designation	Dimensions	Weight
549 3100	REMALINE 60/EP160/CN	6 x 2000 x 10 000 mm	7.62 kg/m ²
549 3131	REMALINE 60/EP160/CN	10 x 2000 x 10 000 mm	12.50 kg/m ²

WEAR PROTECTION LINING

REMALINE – High-quality rubber lining material

REMALINE MP 60 – The perfect way to reliable production planning

REMALINE MP 60 (Maintenance Pro) puts an end to premature, unplanned system downtime and unnecessary maintenance and standstill costs. This new development, which points the way to the future of lining materials, offers you more than just premium surface protection. It also gives you a timely reminder when the lining needs to be renewed. Thus, you can easily plan and schedule to ensure smooth-running production processes, and significantly increased system productivity. A unique advantage, particularly where it is difficult to check the thickness of the lining using conventional methods.

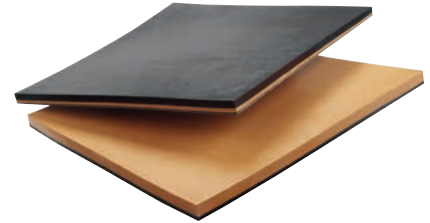

REMALINE MP 60

Properties

- Safe protection against wear and material build-up with built-in wear indicator
- Black wear layer
- Orange signal layer
- Highly wear-resistant, particularly for dry abrasion and impact
- Very elastic
- High self-cleaning effect
- Noise damping; reduces dust formation
- Good weather resistance
- CN bonding layer provides fast and long-lasting adhesion

Area of application

- Especially suitable for conveying components that are hard to access and inspect using conventional methods
- Lining for vibration chutes, slides, material transfer points, truck bodies, impact curtains, bunkers, silos, chutes and sieve basins

REMALINE MP 60/CN

Specifications

Polymer basis	BR/IR/SBR/NR	DIN ISO 1629
Specific weight	1.13 g/cm ³	DIN EN ISO 1183-1
Hardness	60 Shore A	DIN ISO 7619-1
Colour	Black/Orange*	

Ref. No.	Designation	Dimensions	Signal layer	Weight
549 1640	REMALINE MP 60/CN	6(4)x2000x10 000 mm	2 mm	7.27 kg/m ²
549 1641	REMALINE MP 60/CN	10(6)x2000x10 000 mm	4 mm	11.91 kg/m ²
549 1642	REMALINE MP 60/CN	12(8)x2000x10 000 mm	4 mm	14.28 kg/m ²
549 1643	REMALINE MP 60/CN	20(16)x2000x10 000 mm	4 mm	23.86 kg/m ²
549 1644	REMALINE MP 60/CN	25(21)x2000x10 000 mm	4 mm	29.68 kg/m ²
549 1645	REMALINE MP 60/CN	50(40)x2000x10 000 mm	10 mm	59.22 kg/m ²

* (Please note that this is a product based on natural rubber and therefore deviations in colour may occur.)

WEAR PROTECTION LINING

REMALINE – High-quality rubber lining material

REMALINE 70 – Premium quality for tough wear situations

REMALINE 70 is a material featuring especially excellent resistance to abrasion. REMALINE 70 is the material of choice for applications with extremely high wear and impact. Due to its high tear resistance and tensile strength, REMALINE 70 is especially suitable for equipment used to convey large-particle, broken and sharp-edged material.

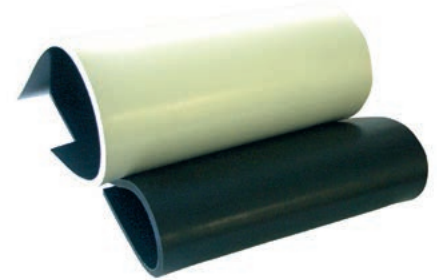

REMALINE 70

Properties

- Superior resistance to wear
- Excellent resistance to abrasion
- Extremely high tensile strength
- Good weather resistance
- CN bonding layer provides fast and long-lasting adhesion

Area of application

- Material transfer points, chutes, bunkers and slides
- Lining for truck bodies, impact curtains and vibrating conveyors
- Lagging for non-driven pulleys with moderate to high belt tension
- Cold refurbishing of conveyor belts
- Mill lining

REMALINE 70/CN

Specifications

Polymer basis	NR/BR	DIN ISO 1629
Specific weight	1.09 g/cm ³	DIN EN ISO 1183-1
Hardness	63 Shore A	DIN ISO 7619-1
Colour	Black	

Ref. No.	Designation	Dimensions	Weight
549 3210	REMALINE 70/CN	3x1500x10 000 mm	4.14 kg/m ²
549 9100	REMALINE 70/CN	5x2000x10 000 mm	6.30 kg/m ²
549 9110	REMALINE 70/CN	6x2000x10 000 mm	7.25 kg/m ²
549 3289	REMALINE 70/CN	8x2000x10 000 mm	9.24 kg/m ²
549 3313	REMALINE 70/CN	10x2000x10 000 mm	11.90 kg/m ²
549 3337	REMALINE 70/CN	12x2000x10 000 mm	14.04 kg/m ²
549 3351	REMALINE 70/CN	15x2000x10 000 mm	17.40 kg/m ²
549 3375	REMALINE 70/CN	20x2000x10 000 mm	23.20 kg/m ²
549 3399	REMALINE 70/CN	25x2000x10 000 mm	28.75 kg/m ²
549 3416	REMALINE 70/CN	30x2000x10 000 mm	34.50 kg/m ²
549 3430	REMALINE 70/CN	40x2000x5000 mm	46.00 kg/m ²
549 3454	REMALINE 70/CN	50x2000x5000 mm	57.50 kg/m ²

WEAR PROTECTION LINING

REMALINE – High-quality rubber lining material

REMALINE 70/EP160 – The fabric reinforced premium quality for tough wear situations

REMALINE 70/EP160 has been specially designed to withstand extreme wear and caking for a variety of wet or dry applications in challenging operating conditions.

Properties

- REMALINE 70 premium quality with fabric reinforcement
- Superior resistance to wear
- Excellent resistance to abrasion
- Extremely high tensile strength
- Good weather resistance
- CN bonding layer provides fast and long-lasting adhesion

Area of application

- Material transfer points, chutes, bunkers and slides
- Lining for truck bodies, impact curtains and vibrating conveyors

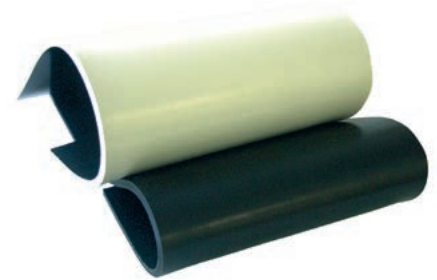

REMALINE 70

REMALINE 70/EP160/CN

Specifications

Polymer basis	NR/BR	DIN ISO 1629
Specific weight	1.09 g/cm ³	DIN EN ISO 1183-1
Hardness	63 Shore A	DIN ISO 7619-1
Colour	Black	

Ref. No.	Designation	Dimensions	Weight
549 3485	REMALINE 70/EP160/CN	6 x 2000 x 10 000 mm	7.50 kg/m ²
549 3502	REMALINE 70/EP160/CN	10 x 2000 x 10 000 mm	12.10 kg/m ²
549 3526	REMALINE 70/EP160/CN	15 x 2000 x 10 000 mm	17.85 kg/m ²
549 3533	REMALINE 70/EP160/CN	20 x 2000 x 10 000 mm	23.60 kg/m ²

WEAR PROTECTION LINING REMALINE – High-quality rubber lining material

REMALINE 70 OIL – The oil and grease resistant premium quality for tough wear situations

REMALINE 70 OIL has been specially designed to withstand tough wear and caking for a variety of wet or dry applications in challenging operating conditions in which oil and grease are or might be involved.

Properties

- Oil and grease resistant REMALINE 70 premium quality
- Superior resistance to wear
- Excellent resistance to abrasion
- Extremely high tensile strength
- Good weather resistance
- CN bonding layer provides fast and long-lasting adhesion

Area of application

- Material transfer points, chutes, bunkers and slides
- Lining for truck bodies, impact curtains and vibrating conveyors

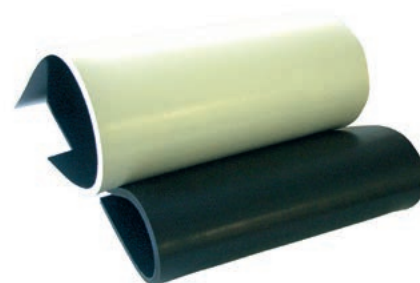

REMALINE 70

REMALINE 70 OIL/CN

Specifications

Polymer basis	NBR	DIN ISO 1629
Specific weight	1.15 g/cm ³	DIN EN ISO 1183-1
Hardness	59 Shore A	DIN ISO 7619-1
Colour	Black	

Ref. No.	Designation	Dimensions	Weight
549 3739	REMALINE 70 OIL/CN	3 x 1500 x 10 000 mm	3.88 kg/m ²
549 9120	REMALINE 70 OIL/CN	6 x 2000 x 10 000 mm	7.75 kg/m ²
549 3571	REMALINE 70 OIL/CN	10 x 2000 x 10 000 mm	12.60 kg/m ²

WEAR PROTECTION LINING

REMALINE – High-quality rubber lining material

REMALINE 70 OIL/EP160 – The fabric reinforced, oil and grease resistant premium quality for tough wear situations

REMALINE 70 OIL/EP160 has been specially designed to withstand tough wear and caking for a variety of wet or dry applications in challenging operating conditions in which oil and grease are or might be involved.

Properties

- Fabric reinforced, oil and grease resistant REMALINE 70 premium quality
- Fabric reinforced
- Superior resistance to wear
- Excellent resistance to abrasion
- Extremely high tensile strength
- Good weather resistance
- CN bonding layer provides fast and long-lasting adhesion

Area of application

- Material transfer points, chutes, bunkers and slides
- Lining for truck bodies, impact curtains and vibrating conveyors



REMALINE 70

REMALINE 70 OIL/EP160/CN

Specifications

Polymer basis	NBR	DIN ISO 1629
Specific weight	1.15 g/cm ³	DIN EN ISO 1183-1
Hardness	59 Shore A	DIN ISO 7619-1
Colour	Black	

Ref. No.	Designation	Dimensions	Weight
549 9130	REMALINE 70 OIL/EP160/CN	6 x 2000 x 10 000 mm	7.80 kg/m ²
549 9140	REMALINE 70 OIL/EP160/CN	10 x 2000 x 10 000 mm	12.40 kg/m ²

WEAR PROTECTION LINING

REMALINE – High-quality rubber lining material

REMALINE 70 V – The self-extinguishing premium quality for tough wear situations

REMALINE 70 V is self-extinguishing and antistatic. It has been specially designed to withstand extreme wear and caking for a variety of wet or dry applications in challenging ATEX operating conditions with high fire regulation or potentially explosive environments.

Required adhesive system for antistatic rubber coatings: PRIMER PR 200 and CEMENT SC 4000 black/HARDENER ER-42 or CEMENT SC 2000 black/HARDENER UT-R 20.

German underground approval: LOBA No. 18.43.21-89-33

Polish underground approval: Dopuszczenie WUG Katowice No. B/1724/III/2013

Properties

- Self-extinguishing, antistatic REMALINE 70 premium quality
- Moderate oil resistance
- Superior resistance to wear
- Excellent resistance to abrasion
- Extremely high tensile strength

- Good weather resistance
- CN bonding layer provides fast and long-lasting adhesion

Area of application

- Material transfer points, chutes, bunkers and slides

- Lining for truck bodies, impact curtains and vibrating conveyors
- Lagging for non-driven pulleys with moderate to high belt tension
- Cold refurbishing of conveyor belts
- Mill lining

REMALINE 70 V/CN

Specifications

Polymer basis	CR	DIN ISO 1629
Specific weight	1.39 g/cm ³	DIN EN ISO 1183-1
Hardness	60 Shore A	DIN ISO 7619-1
Electric resistance	Antistatic*	
Inflammability	Self-extinguishing**	
CN bonding layer	Conductive, black	
Colour	Black	

Ref. No.	Designation	Dimensions	Weight
549 3203	REMALINE 70 V/CN	3x1500x10 000 mm	4.41 kg/m ²
549 3863	REMALINE 70 V/CN	6x2000x10 000 mm	8.82 kg/m ²
549 3935	REMALINE 70 V/CN	10x2000x10 000 mm	14.80 kg/m ²
549 3959	REMALINE 70 V/CN	12x2000x10 000 mm	17.76 kg/m ²
549 3973	REMALINE 70 V/CN	15x2000x10 000 mm	22.20 kg/m ²
549 3997	REMALINE 70 V/CN	20x2000x10 000 mm	29.60 kg/m ²

* (Surface and volume resistivity < 1x10⁶ Ohm, tested in accordance with DIN EN ISO 284, DIN IEC 93.)

** (Fulfills DIN 22100-7 safety requirements (fire safety, hygiene, electrical).)

WEAR PROTECTION LINING

REMALINE – High-quality rubber lining material

REMALINE 70 HR – The heat resistant premium quality for tough wear situations

REMALINE 70 HR is made to withstand a continuous thermal stress of 110 °C and even short-term stresses of 130 °C. It has been specially designed to withstand extreme wear and caking for a variety of wet or dry applications in challenging operating conditions in high-temperature environments

Properties

- Heat resistant REMALINE 70 premium quality up to 110 °C, short peaks up to 130 °C
- Superior resistance to wear
- Excellent resistance to abrasion
- Extremely high tensile strength
- Good weather resistance
- CN bonding layer provides fast and long-lasting adhesion

Area of application

- Material transfer points, chutes, bunkers and slides
- Lining for truck bodies, impact curtains and vibrating conveyors
- Lagging for non-driven pulleys with moderate to high belt tension
- Mill lining

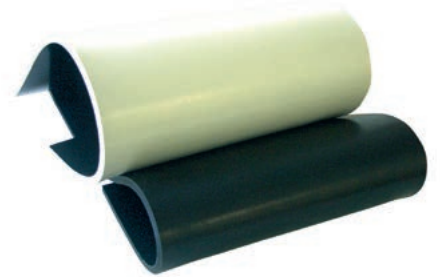

REMALINE 70

REMALINE 70 HR/CN

Specifications

Polymer basis	BR/IR	DIN ISO 1629
Specific weight	1.1 g/cm ³	DIN EN ISO 1183-1
Hardness	60 Shore A	DIN ISO 7619-1
Colour	Black	

Ref. No.	Designation	Dimensions	Weight
549 3715	REMALINE 70 HR/CN	6 x 2000 x 10 000 mm	7.26 kg/m ²
549 3753	REMALINE 70 HR/CN	10 x 2000 x 10 000 mm	12.00 kg/m ²

WEAR PROTECTION LINING REMALINE – High-quality rubber lining material

REMALINE 70 WHITE OIL FOOD – The oil and grease resistant premium food quality for tough wear situations

REMALINE 70 WHITE OIL FOOD has been specially designed for a variety of wet or dry applications against wear and caking in challenging operating conditions. It fulfills the requirements for food contact and can be safely applied in any systems with hygiene requirements in accordance with:

- Federal Institute for Risk Assessment, Recommendations on Food Contact Materials XXI, Cat. 3+4 (Germany)
- Regulation (EU) No. 1935/2004
- FDA Regulation No. 21 CFR 177.2600

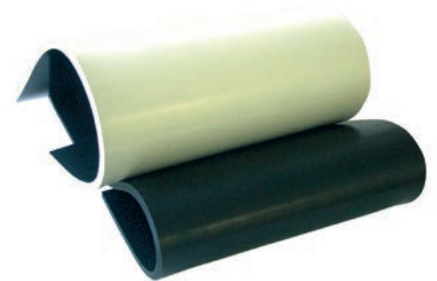

REMALINE 70

Properties

- Oil and grease resistant REMALINE 70 premium quality
- Food quality
- Superior resistance to wear
- Good resistance to abrasion
- Extremely high tensile strength
- Good weather resistance
- CN bonding layer provides fast and long-lasting adhesion

Area of application

- Material transfer points, chutes, bunkers and slides
- Lining for truck bodies, impact curtains and vibrating conveyors
- Lagging for non-driven pulleys with moderate to high belt tension

REMALINE 70 WHITE OIL FOOD/CN

Specifications

Polymer basis	NBR	DIN ISO 1629
Specific weight	1.22 g/cm ³	DIN EN ISO 1183-1
Hardness	56 Shore A	DIN ISO 7619-1
Colour	White	

Ref. No.	Designation	Dimensions	Weight
550 2008	REMALINE 70 WHITE OIL FOOD/CN	3 x 1500 x 10 000 mm	4.08 kg/m ²
549 9170	REMALINE 70 WHITE OIL FOOD/CN	6 x 2000 x 10 000 mm	8.16 kg/m ²
549 9090	REMALINE 70 WHITE OIL FOOD/CN	10 x 2000 x 10 000 mm	13.20 kg/m ²

WEAR PROTECTION LINING

REMALINE – High-quality rubber lining material

REMALINE 90 – The lining for better material flow

REMALINE 90 is a hard-rubber material featuring outstanding sliding properties and wear-resistance. Due to its slippery surface, wear and build-up can be efficiently prevented and material flow improved.

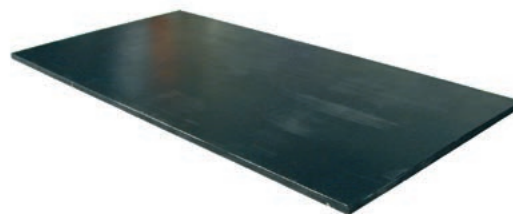

REMALINE 90

Properties

- Safe protection against material flow problems
- Extraordinary hard and smooth surface
- Smoothness increases during operation
- Good weather resistance
- Workable after warming up
- CN bonding layer provides fast and long-lasting adhesion

Area of application

- Especially suitable for lining and coating in foundries, steel mills and glass recycling plants
- Improves flow of material in chutes with fine, grainy materials
- Lining of sliding surfaces
- Lining for electro-magnetic vibratory feeders
- Discharge chutes for waste slag

REMALINE 90/CN

Specifications

Polymer basis	NR/BR	DIN ISO 1629
Specific weight	1.13 g/cm ³	DIN EN ISO 1183-1
Hardness	88 Shore A	DIN ISO 7619-1
Colour	Black	

Ref. No.	Designation	Dimensions	Weight
549 4130	REMALINE 90/CN	6 x 2000 x 10 000 mm	7.68 kg/m ²
549 4154	REMALINE 90/CN	10 x 1000 x 2000 mm	12.50 kg/m ²
549 4178	REMALINE 90/CN	15 x 1000 x 2000 mm	18.75 kg/m ²

WEAR PROTECTION LINING

REMASTAR – High wear-resistance TPU lining material

REMASTAR – Premium quality with extreme abrasion-resistance

REMASTAR is a combination of thermoplastic polyurethane and rubber. It has new and significantly improved features compared to existing lining materials. REMASTAR provides excellent resistance to wear caused by cutting and grooving and remains flexible even at low temperatures. The material is resistant to oil, grease and many solvents and also to ageing.



REMASTAR

Properties

- Excellent abrasion-resistance
- High resistance to wear caused by cutting and grooving
- Resistant to oil, grease and many solvents
- Remains flexible even at low temperatures
- CN bonding layer provides fast and long-lasting adhesion

Area of application

- Lining of vibration chutes, slides, silos, bunkers
- Wear protection of magnetic belts

REMASTAR/CN

Base: Rubber with CN bonding layer, 1 mm

Specifications

Polymer basis	TPU	DIN ISO 1629
Specific weight	1.20 g/cm ³	DIN EN ISO 1183-1
Hardness	85 Shore A	DIN ISO 7619-1
Colour	Red	

Ref. No.	Designation	Dimensions	Weight
549 4482	REMASTAR/CN	6 x 1000 x 10 000 mm	7.4 kg/m ²

WEAR PROTECTION LINING

UNILINE – Rubber lining material for simple applications

UNILINE 40 – The lining for simple applications and wet wear

UNILINE 40 can be universally used as rubber lining for simple applications and wet wear.

Properties

- Wear-resistant
- Good elasticity
- Green contact layer (KS)

Area of application

- Protection against minor, wet wear

UNILINE 40/KS

Specifications

Polymer basis	NR/SBR	DIN ISO 1629
Hardness	45 Shore A	DIN ISO 7619-1
Colour	Black	

Ref. No.	Designation	Dimensions	Weight
550 3503	UNILINE 40/KS	3x1500x10 000 mm	3.75 kg/m ²
550 3433	UNILINE 40/KS	4x2000x10 000 mm	4.96 kg/m ²
550 3432	UNILINE 40/KS	5x2000x10 000 mm	6.50 kg/m ²
550 3421	UNILINE 40/KS	6x2000x10 000 mm	7.25 kg/m ²
550 3446	UNILINE 40/KS	8x2000x10 000 mm	9.49 kg/m ²
550 3453	UNILINE 40/KS	10x2000x10 000 mm	11.87 kg/m ²
550 3540	UNILINE 40/KS	12x2000x10 000 mm	14.11 kg/m ²
550 3479	UNILINE 40/KS	15x2000x10 000 mm	17.64 kg/m ²
550 3486	UNILINE 40/KS	20x2000x10 000 mm	23.31 kg/m ²
550 3493	UNILINE 40/KS	25x2000x10 000 mm	29.14 kg/m ²
550 3449	UNILINE 40/KS	8x1500x10 000 mm	9.49 kg/m ²
550 3456	UNILINE 40/KS	10x1500x10 000 mm	11.87 kg/m ²
550 3480	UNILINE 40/KS	15x1500x10 000 mm	17.64 kg/m ²

WEAR PROTECTION LINING

UNILINE – Rubber lining material for simple applications

UNILINE 60 – The lining for simple applications and dry wear

UNILINE 60 can be universally used as rubber lining for simple applications and dry wear.

Properties

- Wear-resistant
- Good tear growth resistance
- Green contact layer (KS)

Area of application

- Protection against minor, dry wear

UNILINE 60/KS

Specifications

Polymer basis	NR/BR/SBR	DIN ISO 1629
Hardness	62 Shore A	DIN ISO 7619-1
Colour	Black	

Ref. No.	Designation	Dimensions	Weight
550 3351	UNILINE 60/KS	3x1500x10 000 mm	3.97 kg/m ²
550 7520	UNILINE 60/KS	5x2000x10 000 mm	6.51 kg/m ²
550 3280	UNILINE 60/KS	6x2000x10 000 mm	7.81 kg/m ²
550 3296	UNILINE 60/KS	8x2000x10 000 mm	10.33 kg/m ²
550 3306	UNILINE 60/KS	10x2000x10 000 mm	12.92 kg/m ²
550 3313	UNILINE 60/KS	12x2000x10 000 mm	15.37 kg/m ²
550 3320	UNILINE 60/KS	15x2000x10 000 mm	19.22 kg/m ²
550 3337	UNILINE 60/KS	20x2000x10 000 mm	25.62 kg/m ²
550 3344	UNILINE 60/KS	25x2000x10 000 mm	32.03 kg/m ²
550 3920	UNILINE 60/KS	30x2000x10 000 mm	38.43 kg/m ²
550 3270	UNILINE 60/KS	40x2000x5000 mm	50.82 kg/m ²
550 3260	UNILINE 60/KS	50x2000x5000 mm	63.53 kg/m ²
550 3202	UNILINE 60/KS	8x1500x10 000 mm	10.33 kg/m ²
550 3310	UNILINE 60/KS	10x1500x10 000 mm	12.92 kg/m ²
550 3322	UNILINE 60/KS	15x1500x10 000 mm	19.22 kg/m ²

WEAR PROTECTION LINING

REMATHAN – High-quality polyurethane lining material

REMATHAN G 65 – High-quality polyurethane lining material

REMATHAN premium wear protection plates are a convincing choice due to their extremely high wear-resistance and their excellent resistance to oil and grease.

Properties

- High resistance to wear
- Oil and grease resistant
- Resists hydrolysis
- Resists microbes
- High impact elasticity
- High notch value
- Temperature range from –30 °C to +80 °C

Area of application

- Oil-, grease- and wear-resistant lining
- Prevents caking and noise
- Slides and chutes
- Vibratory tumblers



REMATHAN

REMATHAN G 65

Specifications

Polymer basis	PUR	DIN ISO 1629
Specific weight	1.22 g/cm ³	DIN EN ISO 1183-1
Hardness	65 Shore A	DIN ISO 7619-1
Colour	Green	

Ref. No.	Designation	Dimensions
573 2081	REMATHAN G 65	6 x 1400 x 10 000 mm
573 2098	REMATHAN G 65	8 x 1400 x 10 000 mm
573 2108	REMATHAN G 65	10 x 1400 x 10 000 mm
573 0003	REMATHAN G 65	12 x 1400 x 10 000 mm

WEAR PROTECTION LINING

REMATHAN – High-quality polyurethane lining material

REMATHAN G 65/CN – High-quality polyurethane lining material

REMATHAN premium wear protection plates are a convincing choice due to their extremely high wear-resistance and their excellent resistance to oil and grease.

Properties

- High resistance to wear
- Oil and grease resistant
- Resists hydrolysis
- Resists microbes
- High impact elasticity
- High notch value
- Temperature range from -30 °C to +80 °C
- CN bonding layer provides fast and long-lasting adhesion

Area of application

- Oil, grease and wear-resistant lining
- Prevents caking and noise
- Slides and chutes
- Slip ground containers



REMATHAN

REMATHAN G 65/CN

Specifications

Polymer basis	PUR	DIN ISO 1629
Specific weight	1.22 g/cm ³	DIN EN ISO 1183-1
Hardness	65 Shore A	DIN ISO 7619-1
Colour	Green	

Ref. No.	Designation	Dimensions
573 2263	REMATHAN G 65/CN	6 x 1400 x 10 000 mm
573 2270	REMATHAN G 65/CN	8 x 1400 x 10 000 mm
573 2287	REMATHAN G 65/CN	10 x 1400 x 10 000 mm
573 4292	REMATHAN G 65/CN	12 x 1400 x 10 000 mm

WEAR PROTECTION LINING

REMATHAN – High-quality polyurethane lining material

REMATHAN G 75 – High-quality polyurethane lining material

REMATHAN premium wear protection plates are a convincing choice due to their extremely high wear-resistance and their excellent resistance to oil and grease.

Properties

- Excellent resistance to wear
- Oil and grease resistant
- Resists hydrolysis
- Resists microbes
- High impact elasticity
- High notch value
- Temperature range from –30 °C to +80 °C

Area of application

- Oil-, grease- and wear-resistant lining
- Prevents caking and noise
- Slides and chutes
- Slip ground containers
- Concrete discharge chutes



REMATHAN

REMATHAN G 75

Specifications

Polymer basis	PUR	DIN ISO 1629
Specific weight	1.22 g/cm ³	DIN EN ISO 1183-1
Hardness	75 Shore A	DIN ISO 7619-1
Colour	Green	

Ref. No.	Designation	Dimensions
573 2146	REMATHAN G 75	6 x 1400 x 10 000 mm
573 2153	REMATHAN G 75	8 x 1400 x 10 000 mm
573 2160	REMATHAN G 75	10 x 1400 x 10 000 mm
573 4175	REMATHAN G 75	12 x 1400 x 10 000 mm

WEAR PROTECTION LINING

REMATHAN – High-quality polyurethane lining material

REMATHAN G 75/CN – High-quality polyurethane lining material

REMATHAN premium wear protection plates are a convincing choice due to their extremely high wear-resistance and their excellent resistance to oil and grease.

Properties

- Excellent resistance to wear
- Oil and grease resistant
- Resists hydrolysis
- Resists microbes
- High impact elasticity
- High notch value
- Temperature range from -30 °C to +80 °C
- CN bonding layer provides fast and long-lasting adhesion

Area of application

- Oil, grease and wear-resistant lining
- Prevents caking and noise
- Slides and chutes
- Slip ground containers
- Concrete discharge chutes



REMATHAN

REMATHAN G 75/CN

Specifications

Polymer basis	PUR	DIN ISO 1629
Specific weight	1.22 g/cm ³	DIN EN ISO 1183-1
Hardness	75 Shore A	DIN ISO 7619-1
Colour	Green	

Ref. No.	Designation	Dimensions
573 2328	REMATHAN G 75/CN	6 x 1400 x 10 000 mm
573 2335	REMATHAN G 75/CN	8 x 1400 x 10 000 mm
573 2342	REMATHAN G 75/CN	10 x 1400 x 10 000 mm
573 4357	REMATHAN G 75/CN	12 x 1400 x 10 000 mm

WEAR PROTECTION LINING

REMATHAN – High-quality polyurethane lining material

REMATHAN G 90 – High-quality polyurethane lining material

REMATHAN G90 premium wear protection plates are a convincing choice thanks to their extremely high wear-resistance and their excellent resistance to oil and grease.

Properties

- High resistance to wear
- Oil and grease resistant
- Resists hydrolysis
- Resists microbes
- High impact elasticity
- High notch value
- Temperature range from -30 °C to +80 °C

Area of application

- Oil-, grease- and wear-resistant lining
- Prevents caking and noise
- Slides and chutes
- Concrete discharge chutes

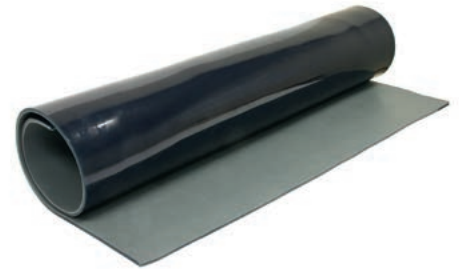

REMATHAN

REMATHAN G 90

Specifications

Polymer basis	PUR	DIN ISO 1629
Specific weight	1.23 g/cm ³	DIN EN ISO 1183-1
Hardness	90 Shore A	DIN ISO 7619-1
Colour	Green	

Ref. No.	Designation	Dimensions
573 2201	REMATHAN G 90	6 x 1400 x 10 000 mm
573 2218	REMATHAN G 90	8 x 1400 x 10 000 mm
573 2225	REMATHAN G 90	10 x 1400 x 10 000 mm
573 4230	REMATHAN G 90	12 x 1400 x 10 000 mm

WEAR PROTECTION LINING

REMATHAN – High-quality polyurethane lining material

REMATHAN G 90/CN – High-quality polyurethane lining material

REMATHAN premium wear protection plates are a convincing choice due to their extremely high wear-resistance and their excellent resistance to oil and grease.

Properties

- High resistance to wear
- Oil and grease resistant
- Resists hydrolysis
- Resists microbes
- High impact elasticity
- High notch value
- Temperature range from -30 °C to +80 °C
- CN bonding layer provides fast and long-lasting adhesion

Area of application

- Oil, grease and wear-resistant lining
- Prevents caking and noise
- Slides and chutes
- Concrete discharge chutes



REMATHAN

REMATHAN G 90/CN

Specifications

Polymer basis	PUR	DIN ISO 1629
Specific weight	1.23 g/cm ³	DIN EN ISO 1183-1
Hardness	90 Shore A	DIN ISO 7619-1
Colour	Green	

Ref. No.	Designation	Dimensions
573 2380	REMATHAN G 90/CN	6 x 1400 x 10 000 mm
573 2397	REMATHAN G 90/CN	8 x 1400 x 10 000 mm
573 2407	REMATHAN G 90/CN	10 x 1400 x 10 000 mm
573 4412	REMATHAN G 90/CN	12 x 1400 x 10 000 mm

● HEAVY WEAR PROTECTION



REMA TIP TOP //

REMALOX – Ceramic/rubber lining material

38-40

Special rubber elements

41-52

HEAVY WEAR PROTECTION

REMALOX – Ceramic/rubber lining material

REMALOX – Ceramic/rubber lining material

REMALOX is a composite construction of highly wear-resistant 92%-Al₂O₃ ceramic tiles (square, rectangular or hexagonal "SW") vulcanized in special rubber with CN bonding layer.

Properties

- CN bonding layer provides fast and long-lasting adhesion
- Highest abrasion-resistance
- Reduces operating costs
- Long service life increases the efficiency of your equipment
- Good resistance against weather

Area of application

- Lining against extreme wear through abrasion at high speeds
- For simple to medium duty applications in mining, gravel, sand and stone breaking mills and other industrial sectors
- In applications like pipelines, vibratory feeders, cyclones, skips, bunkers, chutes, loading points, slides, hoppers, silos, etc.

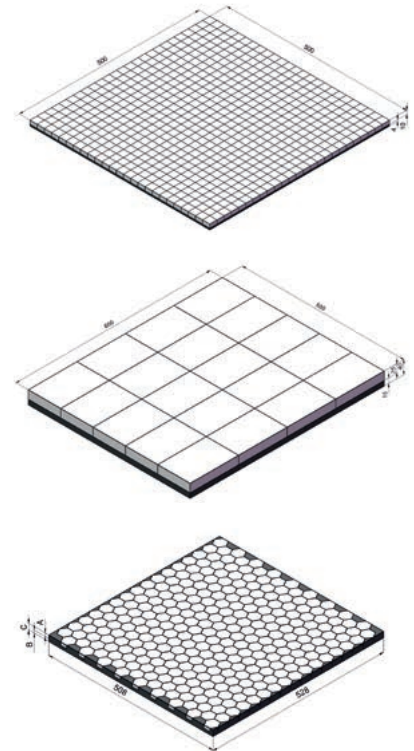

REMALOX

Specifications

Polymer basis	NR/BR/SBR	DIN ISO 1629
Specific weight	1.12 g/cm ³	DIN EN ISO 1183-1
Hardness	62 Shore A	DIN ISO 7619-1
Colour	Black	

Ref. No.	Designation	Dimensions	Dimensions of ceramic tiles	Weight
539 9015	REMALOX 4/4	8 x 500 x 500 mm	4 x 20 x 20 mm	5 kg
539 9022	REMALOX 10/4	14 x 500 x 500 mm	10 x 20 x 20 mm	10 kg
539 9039	REMALOX 25/15	40 x 500 x 600 mm	25 x 100 x 150 mm	32 kg
539 9046	REMALOX SW 6/6	12 x 510 x 525 mm	SW 32 x 6 mm	7 kg
539 9053	REMALOX SW 12/8	20 x 510 x 525 mm	SW 32 x 12 mm	12 kg

HEAVY WEAR PROTECTION

REMALOX – Ceramic/rubber lining material

REMALOX HD 35 – Ceramic/rubber lining material

REMALOX HD 35 is a composite construction of highly wear-resistant 92%-Al₂O₃ ceramic tiles hot vulcanized in special rubber. A 5 mm S235 (St-37) metal layer hot-vulcanized enables an easy fitting to the application areas by means of stud bolt.

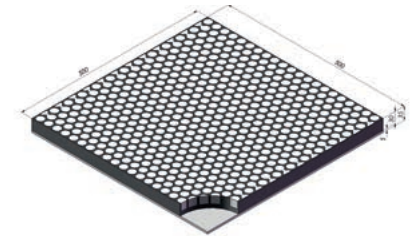

REMALOX HD 35

Properties

- Highest abrasion-resistance
- Absorption of impact energies
- Easy, flexible and fast application with secure fastening
- Reduces operating costs
- Long service life increases the efficiency of your equipment
- Easy replacement
- Good resistance against weather

Area of application

- Lining against extreme wear through abrasion at high speeds
- Lining of material transfer stations with low impact angles
- For simple to medium duty applications in mining, gravel, sand and stone breaking mills and other industrial sectors
- In applications like pipelines, vibratory feeders, cyclones, skips, bunkers, chutes, loading points, slides, hoppers, silos, etc.

REMALOX HD 35

Specifications

Polymer basis	NR/BR/SBR	DIN ISO 1629
Specific weight	1.12 g/cm ³	DIN EN ISO 1183-1
Hardness	62 Shore A	DIN ISO 7619-1
Colour	Black	

Ref. No.	Designation	Dimensions	Dimensions of ceramic tiles	Weight
539 8970	REMALOX HD 35	35 x 250 x 500 mm	Ø 20 x 20 mm	13.7 kg
539 8980	REMALOX HD 35	35 x 500 x 500 mm	Ø 20 x 20 mm	26.7 kg

HEAVY WEAR PROTECTION

REMALOX – Ceramic/rubber lining material

REMALOX HD 75 – Ceramic/rubber lining material

REMALOX HD 75 is a composite construction of highly wear-resistant 92%-Al₂O₃ ceramic tiles hot vulcanized in special rubber. A 5 mm S235 (St-37) metal layer hot-vulcanized enables an easy fitting to the application areas by means of stud bolt.

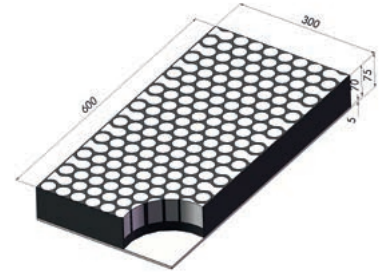

REMALOX HD 75

Properties

- Highest abrasion-resistance
- Absorption of impact energies
- Easy, flexible and fast application with secure fastening
- Reduces operating costs
- Long service life increases the efficiency of your equipment
- Easy replacement
- Good resistance against weather

Area of application

- Lining against extreme wear through impact and abrasion at high speeds
- Lining of material transfer stations with low impact angles
- For heavy to medium duty applications in mining, gravel, sand and stone breaking mills and other industrial sectors
- In applications like pipelines, vibratory feeders, cyclones, skips, bunkers, chutes, loading points, slides, hoppers, silos, etc.

REMALOX HD 75

Specifications

Polymer basis	NR/BR/SBR	DIN ISO 1629
Specific weight	1.12 g/cm ³	DIN EN ISO 1183-1
Hardness	62 Shore A	DIN ISO 7619-1
Colour	Black	

Ref. No.	Designation	Dimensions	Dimensions of ceramic tiles	Weight
539 3200	REMALOX HD 75	75 x 300 x 600 mm	Ø 30 x 50 mm	38.7 kg

HEAVY WEAR PROTECTION

Special rubber elements

KG bars

KG bars with rubber quality REMALINE 70 with excellent resistance against wear in dry conditions and impact energy. Installation by means of vulcanized fastening profile and TT-Fastening Unit.

Properties

- Safe protection against abrasion in addition to impact energies with large-size bulk material
- Easy, flexible and fast application with secure fastening
- Reduces operating costs
- Long service-life increases the efficiency of your equipment
- Easy replacement
- Good resistance against weather

- Also available in V quality (self-extinguishing)

Area of application

- In applications with abrasion at high speeds
- For medium to heavy-duty applications in mining, gravel, sand and stone breaking mills and other industrial sectors
- In applications like bunkers, chutes, loading points

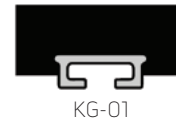

KG-01



KG-02/KG-03/
KG-06/KG-08



KG-04/KG-05/
KG-07



KG-09/KG-10



WKG-01

KG bars

Specifications

Polymer basis	NR/BR	DIN ISO 1629
Specific weight	1.09 g/cm ³	DIN EN ISO 1183-1
Hardness	64 Shore A	DIN ISO 7619-1
Colour	Black	

Ref. No.	Designation	Dimensions	Weight	TT-Fastening Unit
539 0014	KG bars KG-01	50x100x2500 mm	13 kg	I
539 0021	KG bars KG-02	42x100x2500 mm	12 kg	I
539 0038	KG bars KG-03	80x100x2500 mm	22.5 kg	I
539 0045	KG bars KG-04	100x100x2500 mm	28 kg	II
539 0052	KG bars KG-05	100x150x2500 mm	42 kg	II
539 0069	KG bars KG-06	60x100x2500 mm	16 kg	I
539 0076	KG bars KG-07	150x150x2500 mm	62 kg	II
539 0083	KG bars KG-08	80x70x2500 mm	16 kg	I
539 0090	KG bars KG-09	40x40x1000 mm	2.3 kg	III
527 2008	KG bars KG-10	50x50x2500 mm	8.5 kg	III
539 0100	KG bars WKG-01	36x100x2500 mm	9 kg	I

* (Further dimensions on request.)

HEAVY WEAR PROTECTION

Special rubber elements

ZP bars

ZP bars with rubber quality REMALINE 70 with excellent resistance against wear in dry conditions and impact energy. The profile enables a compensation of unfavourable impact angles (for rubber: 10° - 50°). Installation by means of vulcanized fastening profile made of aluminium and TT-Fastening Unit.

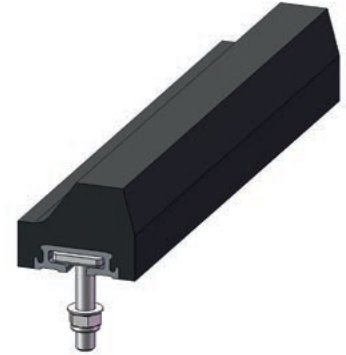

ZP bars

Properties

- Safe protection against abrasion in addition to impact energies with large-size bulk material
- Easy, flexible and fast application with secure fastening
- Reduces operating costs
- Long service-life increases the efficiency of your equipment
- Easy replacement
- Good resistance against weather

Area of application

- In applications with abrasion at high speeds
- For medium to heavy-duty applications in mining, gravel, sand and stone breaking mills and other industrial sectors
- In applications like bunkers, chutes, loading points

ZP bars

Specifications

Polymer basis	NR/BR	DIN ISO 1629
Specific weight	1.09 g/cm ³	DIN EN ISO 1183-1
Hardness	64 Shore A	DIN ISO 7619-1
Colour	Black	

Ref. No.	Designation	Dimensions	Weight	TT-Fastening Unit
539 0148	ZP bars ZP-100	100 x 130 x 2500 mm	29 kg	II
539 0155	ZP bars ZP-150	150 x 190 x 2500 mm	60 kg	II

HEAVY WEAR PROTECTION

Special rubber elements

TT-Fastening Units

TT-Fastening Units I

- Torque: 90 Nm
- Consists of forged TT-Fasteners with washer and self-locking nut
- Recommendation: 4 pieces TT-Fastening Units per metre

Ref. No.	Designation	Dimensions
539 1006	TT-Fastening Unit I	M 16 x 40 mm
539 1013	TT-Fastening Unit I	M 16 x 60 mm
539 1020	TT-Fastening Unit I	M 16 x 80 mm
539 1037	TT-Fastening Unit I	M 16 x 100 mm
539 1044	TT-Fastening Unit I	M 16 x 120 mm

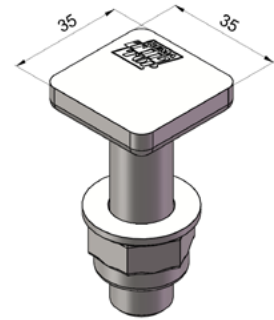

TT-Fastening Units type I

TT-Fastening Units II

- Torque: 150 Nm
- Consists of forged TT-Fasteners with washer and self-locking nut
- Recommendation: 4 pieces TT-Fastening Units per metre

Ref. No.	Designation	Dimensions
539 1068	TT-Fastening Unit II	M 20 x 60 mm
539 1075	TT-Fastening Unit II	M 20 x 80 mm
539 1082	TT-Fastening Unit II	M 20 x 100 mm
539 1099	TT-Fastening Unit II	M 20 x 120 mm

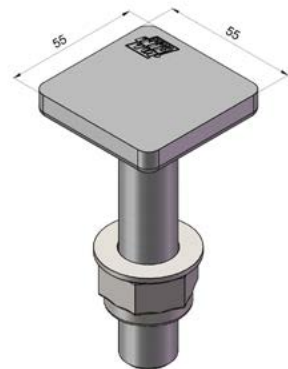

TT-Fastening Units type II

TT-Fastening Units III

- Torque: 15 Nm
- Consists of forged TT-Fasteners with washer and self-locking nut
- Recommendation: 4 pieces TT-Fastening Units per metre

Ref. No.	Designation	Dimensions
539 1460	TT-Fastening Unit III	M 10 x 30 mm
539 1477	TT-Fastening Unit III	M 10 x 60 mm



TT-Fastening Units type III

HEAVY WEAR PROTECTION

Special rubber elements

Serrated profile plates

Serrated profile plates ZP with rubber quality REMALINE 70 with excellent resistance against wear in dry conditions and impact energy. The profile enables a compensation of unfavourable impact angles (for rubber: 10° - 50°).

Properties

- Safe protection against abrasion in addition to impact energies with large-size bulk material
- Easy, flexible and fast application with secure fastening
- Reduces operating costs
- Long service-life increases the efficiency of your equipment

- Easy replacement
- Good resistance against weather

Area of application

- Material transfer points with problematic impact angle
- Impact aprons and elastic impact curtains

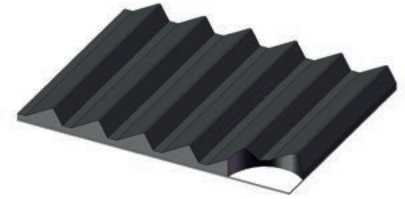

ZP 15 A/ZP 35 A/ZP 55 A



ZP 15 B/ZP 35 B/ZP 55 B

Serrated profile plate ZP A

REMALINE 70 serrated anti-wear rubber on S235 (St-37) steel backing

Specifications

Polymer basis	NR/BR	DIN ISO 1629
Specific weight	1.09 g/cm ³	DIN EN ISO 1183-1
Hardness	64 Shore A	DIN ISO 7619-1
Colour	Black	

Ref. No.	Designation	Dimensions	Weight
539 4278	Serrated profile plate ZP 35 A	15 x 500 x 2520 mm	42 kg
539 4292	Serrated profile plate ZP 35 A	35 x 500 x 2520 mm	59 kg
539 4319	Serrated profile plate ZP 55 A	55 x 500 x 2486 mm	72 kg

Serrated profile plate ZP B

REMALINE 70 serrated anti-wear rubber fabric reinforced (EP 160) and equipped with CN bonding layer.

Ref. No.	Designation	Dimensions	Weight
539 4285	Serrated profile plate ZP 15 B	15 x 500 x 2495 mm	17 kg
539 4302	Serrated profile plate ZP 35 B	35 x 500 x 2495 mm	32 kg
539 4326	Serrated profile plate ZP 55 B	55 x 500 x 2461 mm	47 kg

HEAVY WEAR PROTECTION

Special rubber elements

Serrated profile plate ZPL

REMALINE 70 serrated anti-wear rubber.

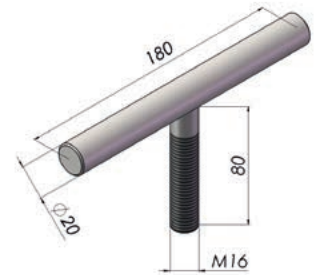
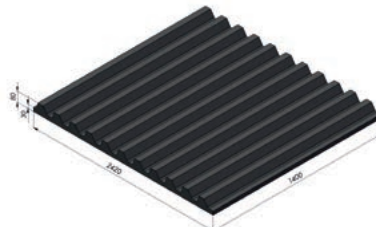

Ref. No.	Designation	Dimensions	Weight	Number of fasteners
539 5301	Serrated profile plate ZPL 40	40 x 1400 x 2420 mm	105 kg	10
539 5318	Serrated profile plate ZPL 60	60 x 1400 x 2420 mm	162 kg	12
539 5325	Serrated profile plate ZPL 80	80 x 1400 x 2420 mm	208 kg	14
539 5332	Serrated profile plate ZPL 100	100 x 1400 x 2420 mm	242 kg	16
539 5349	Serrated profile plate ZPL 120	120 x 1400 x 2420 mm	300 kg	20
539 2861	T screw, for serrated profile plate ZPL	M 16 x 80 mm		

HEAVY WEAR PROTECTION

Special rubber elements

UVZ plates – Serrated rubber plates with metal backing

UVZ plates with rubber quality REMALINE 70 on 5 mm S235 (St-37) metal layer hot-vulcanized with excellent resistance against wear in dry conditions and impact energy. The profile enables a compensation of unfavourable impact angles (for rubber: 10° - 50°). The S235 (St-37) metal layer on the undersurface enables an easy fitting to the application areas and prevents dust and material spillage.



UVZ plate

Properties

- Safe protection against abrasion in addition to impact energies with large-size bulk material
- Easy, flexible and fast application with secure fastening
- Reduces operating costs
- Long service-life increases the efficiency of your equipment

- Easy replacement
- Good resistance against weather

Area of application

- Material transfer points with problematic impact angle
- In applications with abrasion at high speeds

- For medium to heavy-duty applications in mining, gravel, sand and stone breaking mills and other industrial sectors
- In applications like bunkers, chutes, loading points

UVZ plate

Specifications

Polymer basis	NR/BR	DIN ISO 1629
Specific weight	1.09 g/cm ³	DIN EN ISO 1183-1
Hardness	64 Shore A	DIN ISO 7619-1
Colour	Black	

Ref. No.	Designation	Dimensions	Weight
539 7282	UVZ plate	80x450x1000 mm	41 kg
539 7323	UVZ plate	80x500x1000 mm	46 kg
539 7361	UVZ plate	80x600x1000 mm	54 kg
539 7402	UVZ plate	80x750x1000 mm	68 kg
539 7440	UVZ plate	105x450x1000 mm	48 kg
539 7488	UVZ plate	105x500x1000 mm	54 kg
539 7529	UVZ plate	105x600x1000 mm	63 kg
539 7567	UVZ plate	105x750x1000 mm	80 kg
539 7608	UVZ plate	130x450x1000 mm	61 kg
539 7646	UVZ plate	130x500x1000 mm	68 kg
539 7684	UVZ plate	130x600x1000 mm	81 kg
539 9228	UVZ plate	130x750x1000 mm	102 kg

HEAVY WEAR PROTECTION

Special rubber elements

HDL MP plates (Heavy-Duty Lining – Maintenance Pro)

Highly wear-resistant rubber quality REMALINE 70 combined with REMALINE 40 Orange as signal layer hot vulcanized on 5 mm S235 (St-37) steel backing. The thickness of the REMALINE 40 Orange signal layer depends on the total thickness of the HDL MP plates. Fastening holes in a given distance are already properly drilled. The vulcanized steel backing enables an easy fitting to the application areas and prevents dust and material spillage.

Properties

- A precise and reliable production planning is possible (preventive maintenance)
- Excellent wear protection with wear indicator (signal layer)
- Safe protection against abrasion in addition to impact energies with large-size bulk material
- Easy, flexible and fast application with secure fastening
- Reduction of operating costs
- Long service-life increases the efficiency of your equipment
- Easy replacement possible

- Noise and vibration reduction
- Good resistance against weather
- Also available without holes

Area of application

- Highest wear resistance for applications with impact energies and abrasion
- For heavy to medium duty applications in mining, gravel, sand and stone breaking mills and other industrial sectors
- In applications like SKW bodies, bunkers, chutes, loading points, slides, hoppers, silos, etc.

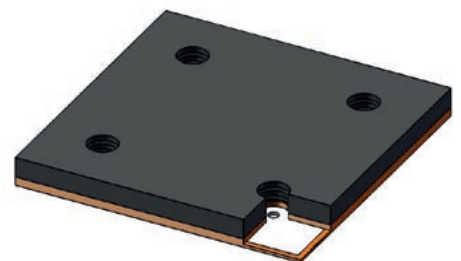

HDL MP plate

HDL MP plate

Specifications

Polymer basis	NR/BR	DIN ISO 1629
Specific weight	1.09 g/cm ³	DIN EN ISO 1183-1
Hardness	64 Shore A	DIN ISO 7619-1
Colour	Black/Orange*	

* (Please note that this is a product based on natural rubber and therefore deviations in colour may occur.)

HEAVY WEAR PROTECTION

Special rubber elements

Ref. No.	Designation	Dimensions	Weight
539 2200	HDL MP plate	50x500x500 mm	22 kg
539 2210	HDL MP plate	60x500x500 mm	25 kg
539 2220	HDL MP plate	80x500x500 mm	30 kg
539 2230	HDL MP plate	100x500x500 mm	35 kg
539 2240	HDL MP plate	120x500x500 mm	40 kg
539 2250	HDL MP plate	150x500x500 mm	49 kg
539 2260	HDL MP plate	50x500x750 mm	33 kg
539 2270	HDL MP plate	60x500x750 mm	37 kg
539 2280	HDL MP plate	80x500x750 mm	45 kg
539 2290	HDL MP plate	100x500x750 mm	53 kg
539 2300	HDL MP plate	120x500x750 mm	61 kg
539 2310	HDL MP plate	150x500x750 mm	73 kg
539 2320	HDL MP plate	50x750x1500 mm	99 kg
539 2330	HDL MP plate	60x750x1500 mm	112 kg
539 2340	HDL MP plate	80x750x1500 mm	136 kg
539 2350	HDL MP plate	100x750x1500 mm	160 kg
539 2360	HDL MP plate	120x750x1500 mm	183 kg
539 2370	HDL MP plate	150x750x1500 mm	220 kg
539 2380	HDL MP plate	50x500x1500 mm	66 kg
539 2390	HDL MP plate	60x500x1500 mm	75 kg
539 2400	HDL MP plate	80x500x1500 mm	90 kg
539 2410	HDL MP plate	100x500x1500 mm	106 kg
539 2420	HDL MP plate	120x500x1500 mm	124 kg
539 2430	HDL MP plate	150x500x1500 mm	147 kg

HEAVY WEAR PROTECTION

Special rubber elements

HDL plates (Heavy-Duty Lining)

Highly wear-resistant rubber quality REMALINE 70 hot vulcanized on on 5 mm S235 (ST-37) split steel backing. Fastening holes in a given distance already properly drilled. The vulcanized steel backing enables an easy fitting to the application areas.

Properties

- Safe protection against abrasion in addition to impact energies with large-size bulk material
- Easy, flexible and fast application with secure fastening
- Reduction of operating costs
- Long service-life increases the efficiency of your equipment
- Easy replacement possible
- Noise and vibration reduction
- Good resistance against weather

- Also available without holes

Area of application

- Highest resistance for applications with impact energies and abrasion
- For heavy to medium duty applications in mining, gravel, sand and stone breaking mills and other industrial sectors
- In applications like SKW bodies, bunkers, chutes, loading points, slides, hoppers, silos, etc.

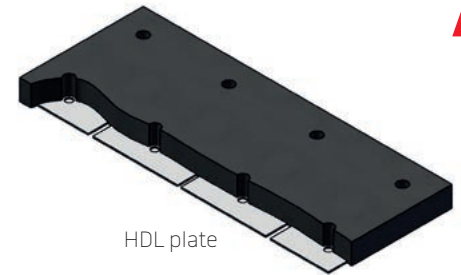

HDL plate

Specifications

Polymer basis	NR/BR	DIN ISO 1629
Specific weight	1.09 g/cm ³	DIN EN ISO 1183-1
Hardness	64 Shore A	DIN ISO 7619-1
Colour	Black	

Ref. No.	Designation	Dimensions	Weight
539 5442	HDL plate	60x500x1 500	74 kg
539 5459	HDL plate	80x500x1 500	91 kg
539 5466	HDL plate	100x500x1 500	107 kg
539 5473	HDL plate	120x500x1 500	124 kg
539 5576	HDL plate	150x500x1 500	148 kg
539 5521	HDL plate	60x750x1 500	113 kg
539 5538	HDL plate	80x750x1 500	138 kg
539 5545	HDL plate	100x750x1 500	162 kg
539 5552	HDL plate	120x750x1 500	187 kg
539 5590	HDL plate	150x750x1 500	224 kg

HEAVY WEAR PROTECTION

Special rubber elements

REMASTEEL 60 – Rubber plates with metal backing

REMASTEEL plates with rubber quality REMALINE 60 with excellent resistance against wear in dry conditions and impact energy. A 3 mm S235 (St-37) metal layer hot vulcanized on the undersurface enables an easy fitting to the application areas and prevents dust and material spillage.

Properties

- Safe protection against abrasion in addition to impact energies with large-size bulk material
- Easy, flexible and fast application with secure fastening
- Reduction of operating costs
- Long service-life increases the efficiency of your equipment
- Easy replacement possible
- Noise and vibration reduction
- Good resistance against weather

Area of application

- Highest resistance for applications with impact energies and abrasion
- For heavy to medium duty applications in mining, gravel, sand and stone breaking mills and other industrial sectors
- In applications like SKW bodies, bunkers, chutes, loading points, slides, hoppers, silos, etc.



REMASTEEL 60

REMASTEEL 60

Specifications

Polymer basis	BR/IR/SBR	DIN ISO 1629
Specific weight	1.13 g/cm ³	DIN EN ISO 1183-1
Hardness	60 Shore A	DIN ISO 7619-1
Colour	Black	

Ref. No.	Designation	Dimensions	Weight
539 1500	REMASTEEL 60	10x1250x2500 mm	98 kg
539 1510	REMASTEEL 60	15x1250x2500 mm	115 kg
539 1520	REMASTEEL 60	20x1250x2500 mm	133 kg
539 1530	REMASTEEL 60	25x1250x2500 mm	150 kg
539 1540	REMASTEEL 60	30x1250x2500 mm	168 kg
539 1550	REMASTEEL 60	40x1250x2500 mm	203 kg
539 2000	REMASTEEL 60	10x300x300 mm	2.8 kg
539 2010	REMASTEEL 60	15x300x300 mm	3.3 kg
539 2020	REMASTEEL 60	20x300x300 mm	3.8 kg
539 2030	REMASTEEL 60	25x300x300 mm	4.3 kg
539 2040	REMASTEEL 60	30x300x300 mm	4.8 kg
539 2050	REMASTEEL 60	40x300x300 mm	5.8 kg

HEAVY WEAR PROTECTION

Special rubber elements

REMASTEEL 70 – Rubber plates with metal backing

REMASTEEL plates with rubber quality REMALINE 70 with excellent resistance against wear in dry conditions and impact energy. A 3 mm S235 (St-37) metal layer hot vulcanized on the undersurface enables an easy fitting to the application areas and prevents dust and material spillage.

Properties

- Safe protection against abrasion in addition to impact energies with large-size bulk material
- Easy, flexible and fast application with secure fastening
- Reduction of operating costs
- Long service-life increases the efficiency of your equipment
- Easy replacement possible
- Noise and vibration reduction
- Good resistance against weather

Area of application

- Highest resistance for applications with impact energies and abrasion
- Heavy to medium duty applications in mining, gravel, sand and stone breaking mills and other industrial sectors
- In applications like SKW bodies, bunkers, chutes, loading points, slides, hoppers, silos, etc.



REMASTEEL 70

REMASTEEL 70

Specifications

Polymer basis	NR/BR	DIN ISO 1629
Specific weight	1.09 g/cm ³	DIN EN ISO 1183-1
Hardness	64 Shore A	DIN ISO 7619-1
Colour	Black	

Ref. No.	Designation	Dimensions	Weight
539 1560	REMASTEEL 70	10x1250x2500 mm	98 kg
539 1570	REMASTEEL 70	15x1250x2500 mm	115 kg
539 1580	REMASTEEL 70	20x1250x2500 mm	133 kg
539 1590	REMASTEEL 70	25x1250x2500 mm	150 kg
539 1600	REMASTEEL 70	30x1250x2500 mm	168 kg
539 1610	REMASTEEL 70	40x1250x2500 mm	203 kg
539 2060	REMASTEEL 70	10x300x300 mm	2.8 kg
539 2070	REMASTEEL 70	15x300x300 mm	3.3 kg
539 2080	REMASTEEL 70	20x300x300 mm	3.8 kg
539 2090	REMASTEEL 70	25x300x300 mm	4.3 kg
539 2100	REMASTEEL 70	30x300x300 mm	4.8 kg
539 2110	REMASTEEL 70	40x300x300 mm	5.8 kg

HEAVY WEAR PROTECTION

Special rubber elements

Accessories – HDL and HDL MP plates

HDL and HDL MP Fastening Unit A

Ref. No.	Designation
539 2696	Hex. bolt, M 20x80 mm
539 2816	Hex. nut, DIN 985, self-locking, M 20
539 4412	Rubber cord, Ø 55x 1000 mm
539 2768	U-washer, DIN 125-St., inside Ø 21 mm
539 2775	U-washer, DIN 7349, outer Ø 44 mm

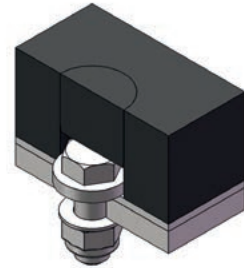

HDL Fastening Unit A

HDL and HDL MP Fastening Unit B

Ref. No.	Designation
539 2720	Stud bolt, M20 x 35 mm
539 2775	U-washer, DIN 7349, outer Ø 44 mm
539 2816	Hex. nut, DIN 985, self-locking, M 20
539 4412	Rubber cord, Ø 55x 1000 mm

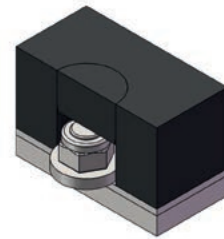

HDL Fastening Unit B

HDL and HDL MP drill

For additional boreholes in rubber such as REMASTEEL.

Ref. No.	Designation
539 4405	HDL drill 50 mm Shaft for drill chuck (rigid shaft Ø 10 mm).



539 4405

● ANTICAKING



REMA TIP TOP



REMAFLON – Non-stick liners

54

REMALEN – Non-stick liners

55

REMASLIDE Plate – Non-stick liners

56

ANTICAKING

REMAFLON – Non-stick liners

REMAFLON – The solution for extreme material flow problems

REMAFLON lining is a combination of polytetrafluorethylene (PTFE = Teflon®) and rubber. They feature especially slippery surfaces, thereby preventing extreme build-up and material flow problems. REMAFLON ensures perfect protection in most applications where dust (non-abrasive) or very fine and slightly moist material prone to build-up has to be conveyed. In particular, the virginal PTFE surface of REMAFLON features outstanding anti-adhesive properties, which make the surface even more slippery.

Properties

- Safe protection from material flow problems
- Excellent anti-caking properties due to the Teflon® surface (PTFE = extremely low adhesion and friction coefficients)
- Extremely good chemical resistance
- Noise damping
- CN bonding layer provides fast and good adhesion
- Teflon® surfaces approved for contact with food

Area of application

- Used for toughest caking and material flow problems requiring the use of Teflon surfaces, such as for REA plaster or for the molasses segment (wet) of the sugar industry
- Flow improvement of very fine and powdery, non-abrasive materials
- Lining to prevent bridging
- Lining for gutters, slides, transfer stations and containers
- Coating for walls and outlet elements in glass production



REMAFLON

REMAFLON

- Surface: White, PTFE virginal, 1 mm
- Base: Rubber (black) with CN bonding layer, 2 mm

Specifications

Polymer basis	PTFE	DIN ISO 1629
Specific weight	2.16 g/cm³	DIN EN ISO 1183-1
Hardness	54 Shore D	DIN ISO 7619-1
Colour	White	

Ref. No.	Designation	Dimensions
550 7004	REMAFLON	3x1200x2000 mm
550 7005	REMAFLON	3x1200x4000 mm
550 7006	REMAFLON	3x1200x6000 mm
550 7007	REMAFLON	3x1200x8000 mm
550 7008	REMAFLON	3x1200x10 000 mm

ANTICAKING

REMALEN – Non-stick liners

REMALEN – The special solution for any material flow problem

REMALEN linings are designed for a specially wide range of applications in a wide area of industry due to their excellent surface quality. Especially when conveying and handling very fine-particle and dust-like material, linings with REMALEN reduce the build-up of fine material to a minimum and thereby increase the productivity of your equipment.

Properties

- Optimum protection from build-up, bridging and against wear
- Noise damping
- Reduction of maintenance costs
- Excellent cost-performance-ratio
- CN bonding layer provides fast and good adhesion
- PE surface is food quality

Area of application

- Prevents flow problems with very fine and powdery, non-abrasive materials
- Used in the storage and transport area for bulk and unit load materials
- Lining for gutters, slides, material transfer stations, pipelines, storage container, funnels, cyclones, cones, etc.



REMALEN

3

REMALEN

- Surface: Transparent, UHMW-PE, 1 mm
- Base: Rubber (black) with CN bonding layer, 2 mm

Specifications

Polymer basis	PE	DIN ISO 1629
Specific weight	0.93 g/cm ³	DIN EN ISO 1183-1
Hardness	61 Shore D	DIN ISO 7619-1
Colour	Transparent	

Ref. No.	Designation	Dimensions
550 9882	REMALEN	3x1450x4000 mm
550 9883	REMALEN	3x1450x6000 mm
550 9884	REMALEN	3x1450x8000 mm
550 9885	REMALEN	3x1450x10 000 mm

ANTICAKING

REMASLIDE Plate – Non-stick liners

REMASLIDE plates – The solution for any material flow problem

REMASLIDE plates are a combination of polyethylene (PE) and high-quality rubber. Due to its excellent anti-adhesion properties, REMASLIDE plates improve the flow of fine and powdery (non-sharp-edged) material and thereby increasing the productivity of your equipment.

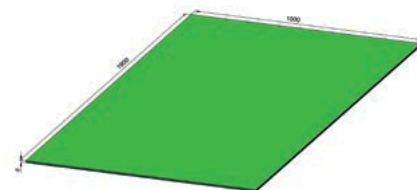

REMASLIDE plate

Properties

- Excellent anti-adhesion properties
- Optimum protection against wear and caking
- CN bonding layer provides fast and good adhesion

Area of application

- Prevents flow problems with fine and powdery (non-sharp-edged) materials for example in coal or ore processing plants or paper, cement or gypsum industry
- Lining for bunkers, silos and other containers as well as their transport through chutes and hoppers

REMASLIDE plate

- Surface: Green, PE-UHMW, 5 mm or 10 mm
- Base: Rubber (black) with CN bonding layer, 3 mm

Specifications

Polymer basis	PE-UHMW	DIN ISO 1629
Specific weight	0.94 g/cm ³	DIN EN ISO 1183-1
Hardness	63 Shore D	DIN ISO 7619-1
Colour	Green	

Ref. No.	Designation	Dimensions
550 7065	REMASLIDE plate	8x1000x1900 mm
550 6963	REMASLIDE plate	13x1000x1900 mm

ADHESIVES AND RUBBER SOLUTIONS



REMA TIP TOP



4

REMABOND Adhesive Systems	58-65
REMAFIX filler and repair pastes	66
Self-vulcanizing repair systems	67-70
Adhesives and rubber solutions based on trichloroethylene	71-73

CEMENT SC 4000

REMA TIP TOP CEMENT SC 4000 processed with HARDENER ER-42 is a trichloro-ethylene-free, two-component bonding system with excellent adhesion and superior dynamic load. It is universally applicable to durable rubber-rubber, rubber-fabric, rubber-metal and fabric-fabric bonds in the fields of wear and corrosion protection as well as in conveyor belt technology.

Properties

- Outstanding initial bonding strength
- High dynamic load rating
- High-strength bonds
- Can be universally used on many materials
- Future-proof, REACH compliance
- Excellent adhesion
- Proven product quality
- Easy to apply
- Brand quality from REMA TIP TOP
- Economic in consumption

- Complements REMA TIP TOP wear protection and repair systems with CN bonding layer
- Good resistance to water, acids and alkalis

Area of application

- Cold splicing and repairs of conveyor belts with fabric reinforcements
- Bonding of rubber components and linings
- Bonding of elastomer laggings for drive pulleys



525 2602



525 1067



525 2619



525 1151

CEMENT SC 4000

CHC-free

High initial adhesion strength. Pot life of 2 hours. Processed with 4 % HARDENER ER-42 or HARDENER E-40 (30 g per 0.7 kg).

Specifications

Polymer basis	CR	DIN ISO 1629
Specific weight	0.96 g/cm ³	
Solvent	Cyclohexane/Ethyl acetate	
Colour	Black, green, white	

Ref. No.	Designation	Colour	Content	Qty	Qty/palett
525 2509	CEMENT SC 4000	green	700 g (780 ml)	10	500
525 2516	CEMENT SC 4000	green	4.5 kg (5 l)	1	80
525 2530	CEMENT SC 4000	green	190 kg (200 l)	1	2

ADHESIVES AND RUBBER SOLUTIONS
 REMABOND Adhesive Systems

Ref. No.	Designation	Colour	Content	Qty	Qty/palett
525 2592	CEMENT SC 4000	black	350 g (390 ml)	20	1000
525 2602	CEMENT SC 4000	black	700 g (780 ml)	10	500
525 2619	CEMENT SC 4000	black	4.5 kg (5 l)	1	80
525 2657	CEMENT SC 4000	black	9 kg (10 l)	1	45
525 2633	CEMENT SC 4000	black	190 kg (200 l)	1	2
525 2704	CEMENT SC 4000	white	700 g (780 ml)	10	720
525 1122	HARDENER E-40		15 g	10	4800
525 1067	HARDENER E-40		30 g	10	4000
525 1116	HARDENER ER-42		15 g	10	4800
525 1151	HARDENER ER-42		30 g	10	4000

ADHESIVES AND RUBBER SOLUTIONS

REMABOND Adhesive Systems

CEMENT MC 2000

REMA TIP TOP CEMENT MC 2000 processed with 4 % HARDENER UT-R 20 is a non-flammable, two-component bonding system with excellent adhesion strength. It can be applied to durable rubber-rubber, rubber-fabric, rubber-metal and fabric-to-fabric bonds in the fields of wear and corrosion protection underground. Furthermore, CEMENT MC 2000 can be used as a heating solution for hot spliced joints as well as repairs of fabric conveyor belts for V-quality cover rubber.

Properties

- Adhesive and heating solution all-in-one
 - High contact adhesion
 - High dynamic load rating
 - High-strength bonds
 - Universal use on many materials
 - Excellent adhesion
 - Easy to apply
 - Brand quality from REMA TIP TOP
 - Economic in consumption
- Complements REMA TIP TOP wear protection and repair systems with CN bonding layer
 - Good resistance against influences such as humidity, acids and brine

Area of application

- Cold splicing and repairs of fabric conveyor belts underground
- Applications in tunnels (fire prevention)
- ATEX applications



525 3160



525 1043

CEMENT MC 2000

Non-flammable

Long drying time. Load bearing after approx. 12 hours. Pot life of 2 hours. Processed with 4 % HARDENER UT-R 20 (40 g per 1 kg).

Specifications

Polymer basis	CR	DIN ISO 1629
Specific weight	1.6 g/cm ³	
Solvent	Perchloroethylene	
Colour	Black	

Ref. No.	Designation	Colour	Content	Qty
525 3160	CEMENT MC 2000	black	1 kg (625 ml)	10
525 1043	HARDENER UT-R 20		40 g	10

CEMENT BC 3004

REMA TIP TOP CEMENT BC 3004 processed with HARDENER ER-42 is a trichloroethylene-free, two-component bonding system. Due to its long open contact adhesion time it is especially suitable for large-area, rubber-rubber, rubber-metal and rubber-concrete bonds in the fields of wear and corrosion protection.

Properties

- Long open time
- High dynamic load rating
- Can be universally used on many materials
- Future-proof, REACH compliance
- Excellent adhesion
- Proven product quality
- Easy to apply
- Brand quality from REMA TIP TOP
- Economic in consumption

- Complements REMA TIP TOP wear and corrosion protection and repair systems with CN bonding layer
- Good resistance to water, acids and alkalis

Area of application

- Tank linings
- Lagging of large-size pulleys
- On-site rubber linings
- Large-area surface protection linings



525 4088



525 1151

CEMENT BC 3004

CHC-free

Long open contact adhesion time – especially for large-area corrosion protection linings. Long curing time. Not suitable for repairing and splicing conveyor belts or for bonding that requires high initial adhesion strength. Processed with 4 % HARDENER ER-42 or HARDENER E-40 (30 g per 0.7 kg).

Specifications

Polymer basis	CR	DIN ISO 1629
Specific weight	0.96 g/cm ³	
Solvent	Cyclohexane/Ethyl acetate	
Colour	Blue	

Ref. No.	Designation	Colour	Content	Qty	Qty/palett
525 4088	CEMENT BC 3004	blue	700 g (780 ml)	10	500
525 4095	CEMENT BC 3004	blue	4.5 kg (5 l)	1	80
525 4143	CEMENT BC 3004	blue	9 kg (10 l)	1	45
525 4130	CEMENT BC 3004	blue	18 kg (20 l)	1	18
525 4105	CEMENT BC 3004	blue	190 kg (200 l)	1	2
525 1067	HARDENER E-40		30 g	10	4000
525 1151	HARDENER ER-42		30 g	10	4000

ADHESIVES AND RUBBER SOLUTIONS

REMABOND Adhesive Systems

CEMENT PC-4

REMA TIP TOP CEMENT PC-4 processed with HARDENER ER-42 is a trichloroethylene-free, two-component bonding system especially developed for the durable splicing of PVC conveyor belts as well as for the repair and bonding of foils and sheets made of soft PVC or polyurethane.

Properties

- Long open time
- High dynamic load rating
- High-strength bonds
- Future-proof, REACH compliance
- Excellent adhesion
- Proven product quality
- Easy to apply

- Brand quality from REMA TIP TOP
- Economic in consumption

Area of application

- Cold splicing and repairs of PVC conveyor belts
- Repair of soft PVC items
- Bonding of polyurethane materials



532 0352



525 1122



525 1151

CEMENT PC-4

CHC-free

Processed with 4 % HARDENER ER-42 or HARDENER E-40 (15 g per 350 g).

Specifications

Polymer basis	PU	DIN ISO 1629
Specific weight	0.83 g/cm ³	
Solvent	Ethylmethylketone	
Colour	Transparent	

Ref. No.	Designation	Colour	Content	Qty
532 0352	CEMENT PC-4	transparent	350 g (440 ml)	20
532 0369	CEMENT PC-4	transparent	9 kg (10.8 l)	1
525 1122	HARDENER E-40		15 g	10
525 1067	HARDENER E-40		30 g	10
525 1116	HARDENER ER-42		15 g	10
525 1151	HARDENER ER-42		30 g	10

METAL PRIMER

REMA TIP TOP METAL PRIMER are used to promote adhesion strength and temperature stability of elastomer-metal bonds with high dynamic and static loads. Primers and adhesives that are designed to work together produce a bonding system with superior stability. Aside of excellent adhesion to rubber-metal, the primers offer additional temporary corrosion protection for the prepared steel surfaces with low consumption of materials and easy application.

Properties

- Future-proof, REACH compliance
- Economic in consumption
- Excellent adhesion in combination with SC 4000, BC 3004
- Short drying time
- Additional temporary protection for atmospheric corrosion (humidity)

Area of application

- METAL PRIMER are used to pretreat metal surfaces of elastomer-metal bonds prior to rubber-metal bonding with high dynamic and static loads



525 4112



525 2406

METAL PRIMER CHC-free

Ref. No.	Designation	Colour	Content	Qty
525 2406	PRIMER PR 200	grey	750 g (810 ml)	10
525 2451	PRIMER PR 200	grey	9 kg (9.7 l)	1
525 4112	PRIMER PR 304	red	750 g (740 ml)	10
525 4150	PRIMER PR 304	red	10 kg (9.8 l)	1

ADHESIVES AND RUBBER SOLUTIONS

REMABOND Adhesive Systems

Cleaning fluid

REMA TIP TOP cleaning fluid provides clean surfaces (free of dust, oil and grease) for all kinds of bondings or coatings. It has proven highly effective for cleaning and removing oil and grease from metal surfaces subsequent to blasting or grinding.

Properties

- Excellent oil and grease-dissolving
- Future-proof, REACH compliance
- Economic in consumption

Area of application

- REMA TIP TOP cleaning fluids can be universally used to remove oil and grease from surfaces and to clean used brushes (i.e. CHC-free adhesive systems, primers, vulcanizing and heating solutions)



595 9118



595 9125

SOLVENT CF-R4

CHC-free

For universal use with CHC-free adhesive systems, primers, vulcanizing and heating solutions. Spray can be used for precise cleaning of small areas.

Ref. No.	Designation	Content	Qty
595 9118	SOLVENT CF-R4	250 ml	25
595 9125	SOLVENT CF-R4	800 ml	10
595 9132	SOLVENT CF-R4	5 l	1
595 9149	SOLVENT CF-R4	500 ml spray	12

SOLVENT CF-CE

CHC-free

For universal use with CHC-free adhesive systems, primers, vulcanizing and heating solutions.

Ref. No.	Designation	Content	Qty
595 9163	SOLVENT CF-CE	10 l	1



595 9132

Accessories

Measuring cup

For dosing adhesives, heating solutions, hardeners, etc.

Ref. No.	Designation
595 8597	Measuring cup, 180 ml, plastic



595 8597

Measuring bucket

For dosing adhesives, heating solutions, hardeners, etc.

Ref. No.	Designation
595 8580	Measuring bucket, 1 l
595 8573	Cover, for measuring bucket, 1 l



595 8580



595 8573

Outlet valve for drums

Outlet valve for 200 l drum with 2 inch bunghole.

Ref. No.	Designation
525 8871	Outlet valve

ADHESIVES AND RUBBER SOLUTIONS

REMAFIX filler and repair pastes

Filler paste for steel and concrete surfaces

REMAFIX L (A+B)

Solvent-free, electrically conductive

REMAFIX L (A+B) is an electrically conductive, reaction hardening, solvent-free two-component synthetic resin product based on an epoxy resin. REMAFIX L (A+B) repair pastes are used to refurbish steel or concrete substrates that are subsequently lined. REMAFIX L (A+B) repair pastes can be used to smooth out small-scaled surface unevenness, such as grooves, troughs and cracks. Due to its conductive properties, a high-voltage test of the lining in accordance with DIN EN 14879-4 is possible.

Ref. No.	Designation	Colour	Content	Qty
528 7055	REMAFIX L (A+B), 2x0.5 kg	black	1 kg	1 set



528 7055

Repair paste for hard-rubber lining

REMAFIX H (A+B)

Solvent-free

REMAFIX H (A+B) is a reaction-hardening, solvent-free material in paste form, used for the repair of small damaged areas such as pores and cracks in hard-rubber lining. REMAFIX H (A+B) is also used as an adhesive paste for applying vulcanized hard-rubber plates to flange surfaces.

Ref. No.	Designation	Colour	Content	Qty
525 0563	REMAFIX H (A+B), 2 x 0.5 kg	black	1 kg	1 set



525 0563

Repair paste for soft-rubber lining

REMAFIX S

Solvent-free

REMAFIX S processed with HARDENER REMAFIX S H3 is a solvent-free, elastic two-component repair kit on a polymer base of a modified poly-butadiene rubber (BR). REMAFIX S, in combination with PRIMER REMAFIX PR 100 bonding primer, displays outstanding adhesion to various substrates, such as steel, soft-rubber lining, hard-rubber lining, graphite components and acid-proof ceramic. Its unique properties are good chemical resistance to non-oxidising mineral acids, bases, aqueous liquors, and especially good resistance to media that feature high content of solids.

Ref. No.	Designation	Colour	Content	Qty
525 2853	REMAFIX S	black	500 g	1
525 2891	HARDENER REMAFIX S H3		25 g	1
525 2901	PRIMER REMAFIX PR 100		250 g	1



525 2853

ADHESIVES AND RUBBER SOLUTIONS

Self-vulcanizing repair systems

FIXPASTE REMAFIX P

REMAFIX P is a one-component fill compound for the filling of small flaws and damaged areas in rubber components based on NR/SBR/IR/BR or blends of these elastomers (such as NR/IR). It is processed with CEMENT SC 4000.

REMAFIX P CHC-free

Ref. No.	Designation	Content	Qty
525 0631	REMAFIX P	700 g (780 ml)	10



525 0631

FIXPASTE VC-4 set

FIXPASTE VC-4 set is a two-component repair compound for the filling of small flaws and damaged areas in rubber components based on NR/SBR/IR/BR or blends of these elastomers (such as NR/IR). It is processed with CEMENT SC-BL.

FIXPASTE VC-4 set CHC-free

Ref. No.	Designation	Content	Qty
516 9087	FIXPASTE VC-4 (A+B), 2x 650 g incl. CEMENT SC-BL, 225 g	1.525 kg	1 set



516 9087

ADHESIVES AND RUBBER SOLUTIONS

Self-vulcanizing repair systems

FIXPASTE REMA GOO

REMA GOO is a special developed solvent-free and UV resistant, two-component polyurethane repair paste for temporary repairs of small and medium damage of conveyor belts or rubber components. REMA GOO can be applied easily and fast to ensure that your plant keeps running and unplanned shutdowns are reduced to a minimum. REMA GOO has unique rubber properties unlike any other product on the market.

Properties

- Short curing time
- Excellent adhesion properties to rubber surfaces
- 60 Shore A nominal hardness
- Hardness remains constant
- High elasticity
- No shrinkage after application
- Excellent oil and diesel fuel resistance properties
- Moderate resistance against chemicals
- Easy and fast application
- No mixing required prior to application
- Material remains usable up to 30 days after opening

- Doubling of adhesive strength by applying REMABOND CEMENT SC 4000

Area of application

- Repair of damaged belt covers
- Temporary repairs of perforations
- For filling of gaps and joints in rubber lining and lagging
- For filling of V-shaped gaps in pulley lagging
- Cosmetic repairing of rubber components



FIXPASTE REMA GOO

Solvent-free

The drying time depends on the ambient temperature and can be accelerated by means of additional heat considerably.

Specifications

Polymer basis	PU	DIN ISO 1629
Specific weight	1.08 g/cm ³	DIN EN ISO 1183-1
Hardness	60 Shore A	DIN ISO 7619-1
Colour	Black	

Ref. No.	Designation	Content	Qty
525 3105	REMA GOO cartridge, incl. 3 mixing nozzles	400 ml	1
525 3112	REMA GOO mixing nozzle, green		1
525 3121	REMA GOO manual cartridge gun		1

ADHESIVES AND RUBBER SOLUTIONS

Self-vulcanizing repair systems

T2 repair system

The two-component T2 repair system is the time-saving, mobile and efficient choice for the repair of damages in belt covers or damages to rubber components based on NR/SBR/IR/BR or blends of these elastomers (such as NR/IR). It is mixed and applied with the REMA TIP TOP COMPOUND MASTER and self-vulcanizes at an ambient temperature of min. 18 °C. An additional vulcanizing system is not needed.

Properties

- Easy and fast application
- No need for special heavy tools and machinery
- Simple to operate
- Very light and transportable for use on-site
- Quick return to service of your plants and equipment (no waiting time after repair)
- Reduces downtime, increases plant availability
- Cost-effective method of repair

Area of application

- For repair of damages in belt covers or longitudinal tears
- For maintenance of gaskets
- For filling of gaps and joints in rubber lining and lagging
- For filling of V-shaped gaps in pulley lagging
- For cosmetic repairing on rubber components



517 9008



517 9015

T2 products

- Processed with SOLUTION T2-A4 and T2-B4 (1:1)
- Application with REMA TIP TOP COMPOUND MASTER
- T2-CL cleaning rubber for cleaning of device

Specifications

Polymer basis	NR	DIN ISO 1629
Specific weight	1.19 g/cm ³	DIN EN ISO 1183-1
Hardness	60 Shore A	DIN ISO 7619-1
Available units	Approx. 2 kg, 6 kg (A+B)	
Colour	Black	

ADHESIVES AND RUBBER SOLUTIONS

Self-vulcanizing repair systems

Ref. No.	Designation	Content	Qty
517 7323	RUBBER T2-A 5 rolls @ 3x20x5500 mm	approx. 2 kg	
517 7330	RUBBER T2-B 5 rolls @ 3x20x5500 mm	approx. 2 kg	
517 7300	RUBBER T2-A, rope	6 kg	
517 7310	RUBBER T2-B, rope	6 kg	
517 7402	RUBBER T2-CL 5 rolls @ 3x18x3000 mm	approx. 1 kg	
517 7420	RUBBER T2-CL, rope	6 kg	
517 9008	SOLUTION T2-A4, CHC-free	700 g (780 ml)	10
517 9015	SOLUTION T2-B4, CHC-free	700 g (780 ml)	10

ADHESIVES AND RUBBER SOLUTIONS BASED ON TRICHLOROETHYLENE (exclusively offered to countries outside of the European Union)

Note

The following products are based on the non-flammable solvent trichloroethylene (CHC) and are exclusively offered to countries outside of the European Union (EU) exworks from the manufacturer. Adhesives and rubber solutions containing trichloroethylene are regulated within the EU by the REACH Regulation policies (EC) No. 1907/2006 of the European Parliament and the regulation (EU) No. 348/2013 of the EU Commission of 17.04.2013 amending Appendix XIV of the REACH Regulation. Following these policies, the ban on the use, storage and transport of CHC for all EU member states comes into effect on 21.04.2016.

For further information please check → www.rtt-tri-free.eu

CEMENT SC 2000

Non-flammable

High initial adhesion strength. Pot life of 2 hours.

Processed with 4 % HARDENER UT-R 20 (40 g per 1 kg) or 3 % HARDENER ER-42 (30 g per 1 kg).

Ref. No.	Designation	Colour	Content	Qty	Made in
525 2025	CEMENT SC 2000	green	1 kg (690 ml)	10	US
525 2027	CEMENT SC 2000	green	1 kg (690 ml)	10	ZA
525 2161	CEMENT SC 2000	black	1 kg (690 ml)	10	ZA
525 2163	CEMENT SC 2000	black	1 kg (690 ml)	10	US
525 2173	CEMENT SC 2000	black	5 kg (3.44 l)	1	US
525 4024	CEMENT SC 2000	black	6 kg (4.1 l)	1	ZA
525 2247	CEMENT SC 2000	white	1 kg (690 ml)	10	US
525 1151	HARDENER ER-42		30 g	10	DE
525 1043	HARDENER UT-R 20		40 g	10	DE

ADHESIVES AND RUBBER SOLUTIONS BASED ON TRICHLOROETHYLENE (exclusively offered to countries outside of the European Union)

CEMENT BC 3000

Non-flammable

Long open contact adhesion time - especially for large-area corrosion protection linings.
Long curing time. Not suitable for repairing and splicing conveyor belts or for bonding
that requires high initial adhesion strength. Processed with 4 % HARDENER UT-R 20
(40 g per 1 kg) or 3 % HARDENER ER-42 (30 g per 1 kg).

Ref. No.	Designation	Colour	Content	Qty	Made in
525 2463	CEMENT BC 3000	blue	1 kg (690 ml)	10	US
525 4063	CEMENT BC 3000	blue	5 kg (3.44 l)	1	US
525 2493	CEMENT BC 3000	blue	290 kg (200 l)	1	US
525 1151	HARDENER ER-42		30 g	10	DE
525 1043	HARDENER UT-R 20		40 g	10	DE

SOLVENT CF-R2

Non-flammable

Cleaning fluid for the removal of oil and grease from surfaces as well as used brushes
(i.e. adhesives, vulcanizing and heating solutions). For use with CHC-containing adhesive
systems and bonding solutions.

Ref. No.	Designation	Content	Qty	Made in
595 9025	SOLVENT CF-R2	800 ml	10	US
595 9027	SOLVENT CF-R2	800 ml	10	ZA
595 9083	SOLVENT CF-R2	3.79 l	1	US

ADHESIVES AND RUBBER SOLUTIONS BASED ON TRICHLOROETHYLENE
(exclusively offered to countries outside of the European Union)

SOLUTION STL-RF

Non-flammable

Heating solution for steel cord conveyor belts.

Ref. No.	Designation	Content	Qty	Made in
538 1239	SOLUTION STL-RF	1 kg (690 ml)	10	ZA

SOLUTION HL-T

Non-flammable

Heating solution for conveyor belts with fabric plies with Standard, K and HR-quality cover rubber sheeting.

Ref. No.	Designation	Content	Qty	Made in
538 1311	SOLUTION HL-T	1 kg (690 ml)	10	ZA

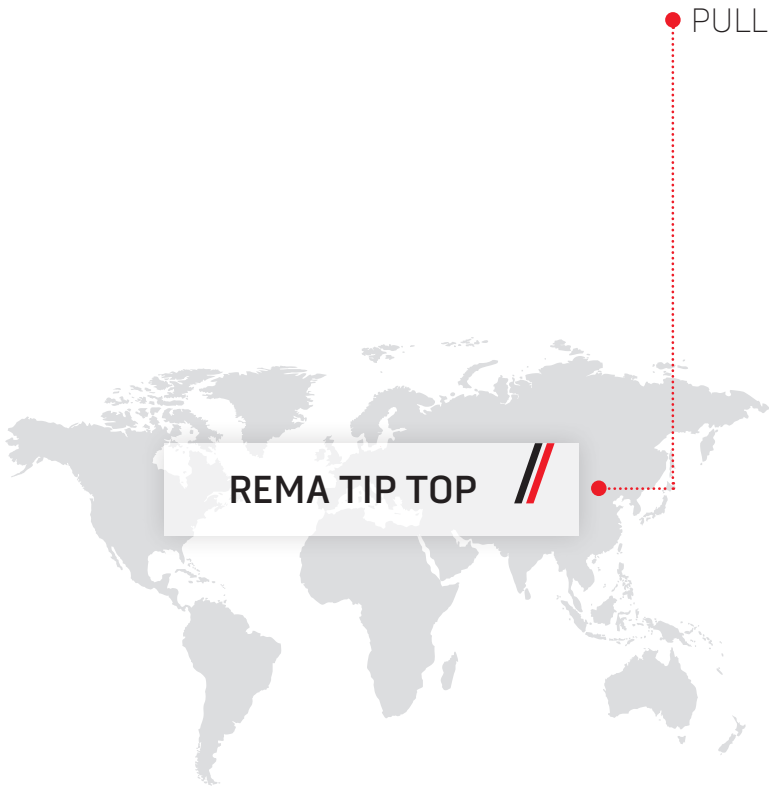

● PULLEY LAGGING

REMA TIP TOP



5

REMAGRIP – High-quality pulley lagging	76-95
UNIGRIP – Drum coating material for simple applications	96-97
UNILAG – Pulley lagging for simple applications	98
Pulley coating	99

PULLEY LAGGING

REMAGRIP – High-quality pulley lagging

REMAGRIP 50 – The universal lagging with high elasticity

REMAGRIP 50 has been designed for a variety of wet or dry applications and can be universally applied as a lagging for drive pulleys for low to medium-loaded fabric belts. Due to its high elasticity, REMAGRIP 50 also features high-qualities for eliminating material build-up (also for non-driven pulleys).

Properties

- Highly elastic, soft lagging for drive pulleys
- Reduces slippage between belt and pulley
- Improves and stabilizes coefficient of friction
- Evacuation of moisture and dirt
- Protects the pulley against wear and corrosion
- Prevents material build-up
- Positive influence on belt tracking

- Excellent self-cleaning properties
- CN bonding layer provides fast and good adhesion

Area of application

- Grooved rubber lagging for drive pulleys
- For low to medium-loaded fabric belts
- For short belt conveyers or small pulley diameters (up to 800 mm)



REMAGRIP 50

REMAGRIP 50/CN

Specifications

Polymer basis	NR	DIN ISO 1629
Specific weight	1.11 g/cm ³	DIN EN ISO 1183-1
Hardness	51 Shore A	DIN ISO 7619-1
Profile	18 x 6 x 3 mm (Profile 20)	
Colour	Orange*	

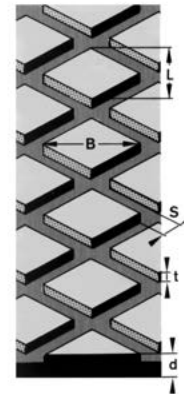

REMAGRIP 50
 B = 35 mm
 L = 18 mm
 S = 6 mm
 t = 3 mm
 d = 8/10/12 mm

Ref. No.	Designation	Dimensions	Weight
549 4548	REMAGRIP 50/CN	8 x 2000 x 10 000 mm	8.56 kg/m ²
549 4605	REMAGRIP 50/CN	10 x 2000 x 10 000 mm	10.60 kg/m ²
549 4667	REMAGRIP 50/CN	12 x 2000 x 10 000 mm	12.72 kg/m ²

* (Please note that this is a product based on natural rubber and therefore variations in color may occur.)

PULLEY LAGGING

REMAGRIP – High-quality pulley lagging

REMAGRIP 60 – The universal lagging with high wear-resistance

REMAGRIP 60 has been designed for a variety of wet or dry applications and can be universally applied as a lagging for drive pulleys for low to medium-loaded fabric belts. REMAGRIP 60 offers optimum wear-resistance and also features excellent qualities for eliminating material build-up (also for non-driven pulleys).

Properties

- Excellent wear-resistance
- Reduces slippage between belt and pulley
- Improves and stabilizes coefficient of friction
- Evacuation of moisture and dirt
- Protects the pulley against wear and corrosion
- Prevents material build-up

- Positive influence on belt tracking
- CN bonding layer provides fast and good adhesion

Area of application

- Grooved rubber lagging for drive pulleys
- For low to medium-loaded fabric belts
- Small pulley diameters (up to 800 mm)



REMAGRIP 60

REMAGRIP 60/CN

Specifications

Polymer basis	BR/IR/SBR	DIN ISO 1629
Specific weight	1.12 g/cm ³	DIN EN ISO 1183-1
Hardness	62 Shore A	DIN ISO 7619-1
Profile	18 x 6 x 3 mm (Profile 20)	
Colour	Black	

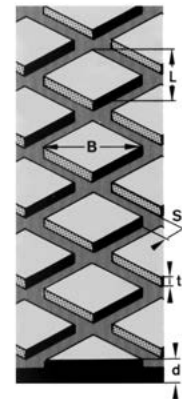

REMAGRIP 60
 B = 35 mm
 L = 18 mm
 S = 6 mm
 t = 3 mm
 d = 8/10/12/15 mm

Ref. No.	Designation	Dimensions	Weight
549 4708	REMAGRIP 60/CN	6 x 2000 x 10 000 mm	6.55 kg/m ²
549 4715	REMAGRIP 60/CN	8 x 1200 x 10 000 mm	8.96 kg/m ²
549 4739	REMAGRIP 60/CN	8 x 1500 x 10 000 mm	8.96 kg/m ²
549 4746	REMAGRIP 60/CN	8 x 1600 x 10 000 mm	8.96 kg/m ²
549 4753	REMAGRIP 60/CN	8 x 2000 x 10 000 mm	8.96 kg/m ²
549 4777	REMAGRIP 60/CN	10 x 1200 x 10 000 mm	11.20 kg/m ²
549 4791	REMAGRIP 60/CN	10 x 1500 x 10 000 mm	11.20 kg/m ²
549 4801	REMAGRIP 60/CN	10 x 1600 x 10 000 mm	11.20 kg/m ²
549 4819	REMAGRIP 60/CN	10 x 2000 x 10 000 mm	11.20 kg/m ²
549 4877	REMAGRIP 60/CN	12 x 2000 x 10 000 mm	13.44 kg/m ²
549 4904	REMAGRIP 60/CN	15 x 2000 x 10 000 mm	17.10 kg/m ²

PULLEY LAGGING

REMAGRIP – High-quality pulley lagging

REMAGRIP 60 V – The self-extinguishing universal lagging with high wear-resistance

REMAGRIP 60 V is self-extinguishing and antistatic. It has been specially designed for ATEX operating conditions with high fire regulation or potentially explosive environments such as coal mines or power plants.

Required adhesive system for antistatic rubber coatings: PRIMER PR 200 and CEMENT SC 4000 black/HARDENER ER-42 or CEMENT SC 2000 black/HARDENER UT-R 20.

German underground approval: LOBA No. 18.43.21-89-33

Polish underground approval: Dopuszczenie WUG Katowice No. B/1724/III/2013

Properties

- Self-extinguishing, antistatic and moderate oil resistant REMAGRIP 60 premium quality
- Excellent wear-resistance
- Reduces slippage between belt and pulley
- Improves and stabilizes coefficient of friction
- Evacuation of moisture and dirt
- Protects the pulley against wear and corrosion

- Prevents material build-up
- Positive influence on belt tracking
- CN bonding layer provides fast and good adhesion

Area of application

- Grooved rubber lagging for drive pulleys
- For low to medium-loaded fabric belts
- Small pulley diameters (up to 800 mm)



REMAGRIP 60 V

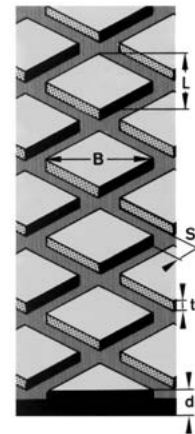

REMAGRIP 60
 B = 35 mm
 L = 18 mm
 S = 6 mm
 t = 3 mm
 d = 8/10/12 mm

REMAGRIP 60 V/CN

Specifications

Polymer basis	CR	DIN ISO 1629
Specific weight	1.39 g/cm ³	DIN EN ISO 1183-1
Hardness	60 Shore A	DIN ISO 7619-1
Electric resistance	Antistatic*	
Inflammability	Self-extinguishing**	
CN bonding layer	Conductive, black	
Profile	18 x 6 x 3 mm (Profile 20)	
Colour	Black	

Ref. No.	Designation	Dimensions	Weight
549 6782	REMAGRIP 60 V/CN	10 x 2000 x 10 000 mm	13.20 kg/m ²
549 5075	REMAGRIP 60 V/CN	12 x 2000 x 10 000 mm	15.84 kg/m ²

* (Surface and volume resistivity)
 $< 1 \times 10^6$ Ohm, tested in accordance
 with DIN EN ISO 284, DIN IEC 93.

** (Fulfills DIN 22100-7 safety
 requirements (fire safety, hygiene,
 electrical).)

PULLEY LAGGING

REAGRIP – High-quality pulley lagging

REAGRIP 60 OIL – The oil and grease resistant universal lagging with high wear-resistance

REAGRIP 60 OIL has been specially designed for operating conditions in which oil and grease are or might be involved and can be universally applied as a lagging for drive pulleys for a variety of wet or dry applications.

Properties

- Oil and grease resistant REAGRIP 60 premium quality
- Excellent wear-resistance
- Reduces slippage between belt and pulley
- Improves and stabilizes coefficient of friction
- Evacuation of moisture and dirt
- Protects the pulley against wear and corrosion

- Prevents material build-up
- Positive influence on belt tracking
- CN bonding layer provides fast and good adhesion

Area of application

- Grooved rubber lagging for drive pulleys
- For low to medium-loaded fabric belts
- Small pulley diameters (up to 800 mm)



REAGRIP 60 OIL

REAGRIP 60 OIL/CN

Specifications

Polymer basis	NBR	DIN ISO 1629
Specific weight	1.15 g/cm ³	DIN EN ISO 1183-1
Hardness	59 Shore A	DIN ISO 7619-1
Profile	18 x 6 x 3 mm (Profile 20)	
Colour	Black	

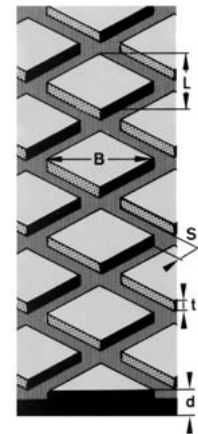

REAGRIP 60
 B = 35 mm
 L = 18 mm
 S = 6 mm
 t = 3 mm
 d = 8/10/12 mm

Ref. No.	Designation	Dimensions	Weight
549 5116	REAGRIP 60 OIL/CN	8 x 2000 x 10 000 mm	8.96 kg/m ²
549 5138	REAGRIP 60 OIL/CN	10 x 2000 x 10 000 mm	11.20 kg/m ²
549 5154	REAGRIP 60 OIL/CN	12 x 2000 x 10 000 mm	13.44 kg/m ²

PULLEY LAGGING

REAGRIP – High-quality pulley lagging

REAGRIP 60 HR – The heat resistant universal lagging with high wear-resistance

REAGRIP 60 HR has been specially designed as a lagging for drive pulleys in operating conditions with high-temperature environments. It is able to withstand a continuous thermal stress of 90 °C and even short-term stress of 110 °C.

Properties

- Heat resistant REAGRIP 60 premium quality
- Excellent wear-resistance
- Reduces slippage between belt and pulley
- Improves and stabilizes coefficient of friction
- Evacuation of moisture and dirt
- Protects the pulley against wear and corrosion

- Prevents material build-up
- Positive influence on belt tracking
- CN bonding layer provides fast and good adhesion

Area of application

- Grooved rubber lagging for drive pulleys
- For low to medium-loaded fabric belts
- Small pulley diameters (up to 800 mm)



REAGRIP 60 HR

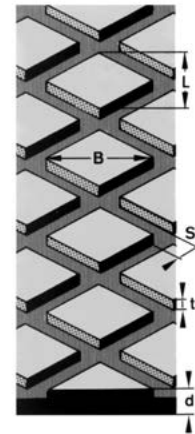

REAGRIP 60
 B = 35 mm
 L = 18 mm
 S = 6 mm
 t = 3 mm
 d = 8/10/12 mm

REAGRIP 60 HR/CN

Specifications

Polymer basis	BR/IR	DIN ISO 1629
Specific weight	1.11 g/cm ³	DIN EN ISO 1183-1
Hardness	60 Shore A	DIN ISO 7619-1
Profile	18 x 6 x 3 mm (Profile 20)	
Max. temperature	up to 90 °C, short peaks up to 110 °C	
Colour	Black	

Ref. No.	Designation	Dimensions	Weight
549 5305	REAGRIP 60 HR/CN	8 x 2000 x 10 000 mm	8.64 kg/m ²
549 5329	REAGRIP 60 HR/CN	10 x 2000 x 10 000 mm	10.80 kg/m ²
549 5358	REAGRIP 60 HR/CN	12 x 2000 x 10 000 mm	12.96 kg/m ²

PULLEY LAGGING

REMAGRIP – High-quality pulley lagging

REMAGRIP 60 WHITE OIL FOOD – The oil and grease resistant universal lagging with high wear-resistance for food contact

REMAGRIP 60 WHITE OIL FOOD can be applied as a lagging for drive pulleys for a variety of wet or dry applications. It fulfills the requirements for food contact and can be safely applied in any systems with hygiene requirements in accordance with:

- Federal Institute for Risk Assessment, Recommendations on Food Contact Materials XXI, Cat. 3+4 (Germany)
- Regulation (EU) No. 1935/2004
- FDA Regulation No. 21 CFR 177.2600

Properties

- Oil and grease resistant REMAGRIP 60 premium quality
- Food quality
- Reduces slippage between belt and pulley
- Improves and stabilizes coefficient of friction
- Evacuation of moisture and dirt
- Protects the pulley against wear and corrosion

- Prevents material build-up
- Positive influence on belt tracking
- CN bonding layer provides fast and good adhesion

Area of application

- Grooved rubber lagging for drive pulleys
- For low to medium-loaded fabric belts
- Small pulley diameters (up to 800 mm)



REMAGRIP 60 WHITE OIL FOOD

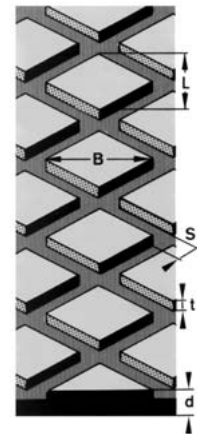

REMAGRIP 60
 B = 35 mm
 L = 18 mm
 S = 6 mm
 t = 3 mm
 d = 8/10/12 mm

REMAGRIP 60 WHITE OIL FOOD/CN

Specifications

Polymer basis	NBR	DIN ISO 1629
Specific weight	1.22 g/cm ³	DIN EN ISO 1183-1
Hardness	56 Shore A	DIN ISO 7619-1
Profile	18 x 6 x 3 mm (Profile 20)	
Colour	White	

Ref. No.	Designation	Dimensions	Weight
549 5468	REMAGRIP 60 WHITE OIL FOOD/CN	8 x 2000 x 10 000 mm	8.72 kg/m ²
549 5477	REMAGRIP 60 WHITE OIL FOOD/CN	10 x 2000 x 10 000 mm	11.20 kg/m ²
549 5484	REMAGRIP 60 WHITE OIL FOOD/CN	12 x 2000 x 10 000 mm	13.45 kg/m ²

PULLEY LAGGING

REMAGRIP – High-quality pulley lagging

REMAGRIP 65 – The universal lagging for medium-duty operating conditions

REMAGRIP 65 has been designed for a variety of wet or dry applications and can be universally applied as a lagging for driven as well as non-driven pulleys for medium-loaded fabric and steel cord belts. REMAGRIP 65 offers optimum abrasion-resistance and also features excellent qualities for eliminating material build-up.

Properties

- Excellent wear-resistance
- Reduces slippage between belt and pulley
- Improves and stabilizes coefficient of friction
- Evacuation of moisture and dirt
- Protects the pulley against wear and corrosion
- Prevents material build-up

- Positive influence on belt tracking
- CN bonding layer provides fast and good adhesion

Area of application

- For medium-strength fabric and steel cord belts
- Grooved rubber lagging for drive pulleys



REMAGRIP 65

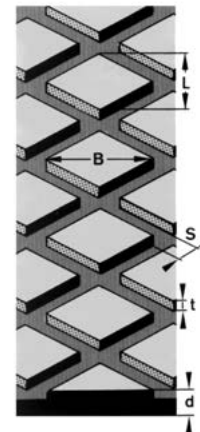

REMAGRIP 65
 B = 86 mm
 L = 50 mm
 S = 6 mm
 t = 3 mm
 d = 8/10/12 mm

REMAGRIP 65/CN

Specifications

Polymer basis	BR/IR/SBR	DIN ISO 1629
Specific weight	1.12 g/cm ³	DIN EN ISO 1183-1
Hardness	62 Shore A	DIN ISO 7619-1
Profile	50 x 6 x 3 mm (Profile 50)	
Colour	Black	

Ref. No.	Designation	Dimensions	Weight
549 5549	REMAGRIP 65/CN	8 x 2000 x 10 000 mm	9.60 kg/m ²
549 5556	REMAGRIP 65/CN	10 x 1200 x 10 000 mm	11.80 kg/m ²
549 5580	REMAGRIP 65/CN	10 x 1500 x 10 000 mm	11.80 kg/m ²
549 5587	REMAGRIP 65/CN	10 x 1600 x 10 000 mm	11.80 kg/m ²
549 5594	REMAGRIP 65/CN	10 x 2000 x 10 000 mm	11.80 kg/m ²
549 5604	REMAGRIP 65/CN	12 x 1200 x 10 000 mm	14.40 kg/m ²
549 5626	REMAGRIP 65/CN	12 x 1500 x 10 000 mm	14.40 kg/m ²
549 5635	REMAGRIP 65/CN	12 x 1600 x 10 000 mm	14.40 kg/m ²
549 5643	REMAGRIP 65/CN	12 x 2000 x 10 000 mm	14.40 kg/m ²

PULLEY LAGGING

REMAGRIP – High-quality pulley lagging

REMAGRIP 65 V – The self-extinguishing, universal lagging for medium-duty operating conditions

REMAGRIP 65 V is self-extinguishing and antistatic. It has been specially designed for ATEX operating conditions with high fire regulation or potentially explosive environments such as coal mines or power plants.

Required adhesive system for antistatic rubber coatings: PRIMER PR 200 and CEMENT SC 4000 black/HARDENER ER-42 or CEMENT SC 2000 black/HARDENER UT-R 20.

German underground approval: LOBA No. 18.43.21-89-33

Polish underground approval: Dopuszczenie WUG Katowice No. B/1724/III/2013



REMAGRIP 65 V

Properties

- Self-extinguishing, antistatic REMAGRIP 65 premium quality
- Excellent wear-resistance
- Reduces slippage between belt and pulley
- Improves and stabilizes coefficient of friction
- Evacuation of moisture and dirt
- Protects the pulley against wear and corrosion

- Prevents material build-up
- Positive influence on belt tracking
- CN bonding layer provides fast and good adhesion

Area of application

- For medium-strength fabric and steel cord belts
- Grooved rubber lagging for drive pulleys

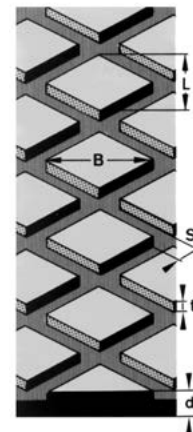

REMAGRIP 65

B = 86 mm
L = 50 mm
S = 6 mm
t = 3 mm
d = 8/10/12 mm

REMAGRIP 65 V/CN

Specifications

Polymer basis	CR	DIN ISO 1629
Specific weight	1.39 g/cm ³	DIN EN ISO 1183-1
Hardness	60 Shore A	DIN ISO 7619-1
Electric resistance	Antistatic*	

Specifications

Inflammability	Self-extinguishing**
CN bonding layer	Conductive, black
Profile	50 x 6 x 3 mm (Profile 50)
Colour	Black

Ref. No.	Designation	Dimensions	Weight
549 5707	REMAGRIP 65 V/CN	8 x 2000 x 10 000 mm	11.36 kg/m ²
550 3075	REMAGRIP 65 V/CN	10 x 2000 x 10 000 mm	14.20 kg/m ²
550 3123	REMAGRIP 65 V/CN	12 x 2000 x 10 000 mm	17.04 kg/m ²

* (Surface and volume resistivity <math> < 1 \times 10^6 \text{ Ohm}</math>, tested in accordance with DIN EN ISO 284, DIN IEC 93. **Fulfills DIN 22100-7 safety requirements (fire safety, hygiene, electrical).)

PULLEY LAGGING

REMAGRIP – High-quality pulley lagging

REMALINE 65 – The smooth lagging for individual grooving

REMAGRIP 65 has been designed for a variety of wet or dry applications and can be universally applied as a lagging for driven as well as non-driven pulleys for fabric and steel cord belts. The plain surface can be individually regrooved with the RUBBER CUT system and perfectly fitted to the requested application.

Properties

- Smooth lagging for individual grooving
- Reduces slippage between belt and pulley
- Improves the coefficient of friction
- Protects the pulley against wear and corrosion
- Pulley lagging to prevent material build-up, with positive influence on belt tracking

- Production of custom groove designs is possible (such as arrowhead design)
- CN bonding layer provides fast and good adhesion

Area of application

- For individual regrooving with the RUBBER CUT system
- For medium-strength fabric and steel cord belts



REMALINE 65

REMALINE 65/CN

Specifications

Polymer basis	BR/IR/SBR	DIN ISO 1629
Specific weight	1.12 g/cm ³	DIN EN ISO 1183-1
Hardness	62 Shore A	DIN ISO 7619-1
Colour	Black	

Ref. No.	Designation	Dimensions	Weight
549 0062	REMALINE 65/CN	8 x 2000 x 10 000 mm	10.00 kg/m ²
549 0079	REMALINE 65/CN	10 x 1500 x 10 000 mm	12.40 kg/m ²
549 0086	REMALINE 65/CN	10 x 2000 x 10 000 mm	12.40 kg/m ²
549 0103	REMALINE 65/CN	12 x 2000 x 10 000 mm	14.76 kg/m ²
549 0110	REMALINE 65/CN	15 x 1500 x 10 000 mm	18.30 kg/m ²
549 0127	REMALINE 65/CN	15 x 2000 x 10 000 mm	18.30 kg/m ²
549 0141	REMALINE 65/CN	20 x 2000 x 10 000 mm	24.40 kg/m ²

PULLEY LAGGING

REMAGRIP – High-quality pulley lagging

REMAGRIP 70 – The universal lagging for heavy-duty operating conditions

REMAGRIP 70 has been designed for a variety of wet or dry applications and can be universally applied as a lagging for driven pulleys for heavy-loaded fabric and steel cord belts. REMAGRIP 70 offers optimum abrasion-resistance, the deep grooving enables the handling of large amounts of dirt and provides a long operating life.

Properties

- Reduces slippage between belt and pulley
- Improves and stabilizes coefficient of friction
- Evacuation of moisture and dirt
- Protects the pulley from wear and corrosion
- Prevents material build-up
- Positive influence on belt tracking
- Deep grooving to handle large amounts of dirt and provide long operating life

- CN bonding layer provides fast and good adhesion

Area of application

- Grooved rubber lagging for drive pulleys
- Long belt conveyors
- Large pulley diameters (from 800 mm)
- For high-tension fabric and steel cord belts of all strengths



REMAGRIP 70

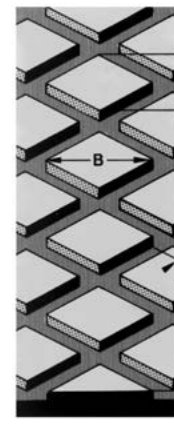

REMAGRIP 70

8x6:

- B = 86 mm
- L = 50 mm
- S = 8 mm
- t = 6 mm
- d = 10/12/15 mm

10x8:

- B = 86 mm
- L = 50 mm
- S = 10 mm
- t = 8 mm
- d = 15/20 mm

REMAGRIP 70/CN

Specifications

Polymer basis	BR/IR/SBR	DIN ISO 1629
Specific weight	1.12 g/cm ³	DIN EN ISO 1183-1
Hardness	62 Shore A	DIN ISO 7619-1
Profile	8x6 or 10x8 (Profile 50)	
Colour	Black	

Ref. No.	Designation	Dimensions	Profile	Weight
549 5798	REMAGRIP 70/CN	10x2000x10 000 mm	8x6 mm	10.20 kg/m ²
549 5805	REMAGRIP 70/CN	12x2000x10 000 mm	8x6 mm	12.30 kg/m ²
549 5817	REMAGRIP 70/CN	15x2000x10 000 mm	8x6 mm	15.86 kg/m ²
549 5824	REMAGRIP 70/CN	15x2000x10 000 mm	10x8 mm	14.40 kg/m ²
549 5831	REMAGRIP 70/CN	20x2000x10 000 mm	10x8 mm	20.33 kg/m ²

PULLEY LAGGING

REMAGRIP – High-quality pulley lagging

REMAGRIP 70 V – The self-extinguishing universal lagging for heavy-duty operating conditions

REMAGRIP 70 V is self-extinguishing and antistatic. It has been specially designed for ATEX operating conditions with high fire regulation or potentially explosive environments such as coal mines or power plants.

Required adhesive system for antistatic rubber coatings: PRIMER PR 200 and CEMENT SC 4000 black/HARDENER ER-42 or CEMENT SC 2000 black/HARDENER UT-R 20.

German underground approval: LOBA No. 18.43.21-89-33.

Polish underground approval: Dopuszczenie WUG Katowice No. B/1724/III/2013



REMAGRIP 70 V

Properties

- Self-extinguishing, antistatic and moderate oil resistant REMAGRIP 70 premium quality
- Reduces slippage between belt and pulley
- Improves and stabilizes coefficient of friction
- Evacuation of moisture and dirt
- Protects the pulley from wear and corrosion
- Prevents material build-up
- Positive influence on belt tracking
- Deep grooving to handle large amounts of dirt and provide long operating life
- CN bonding layer provides fast and good adhesion

Area of application

- Grooved rubber lagging for drive pulleys
- Long belt conveyors
- Large pulley diameters (from 800 mm)
- For high-tension fabric and steel cord belts of all strengths

REMAGRIP 70 V/CN

Specifications

Polymer basis	CR	DIN ISO 1629
Specific weight	1.39 g/cm ³	DIN EN ISO 1183-1
Hardness	60 Shore A	DIN ISO 7619-1
Electric resistance	Antistatic*	
Inflammability	Self-extinguishing**	
CN bonding layer	Conductive, black	
Profile	8x6 or 10x8 (Profile 50)	
Colour	Black	

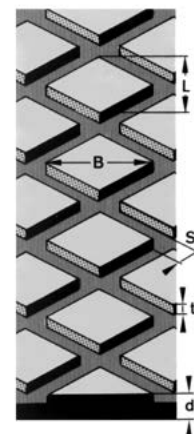

REMAGRIP 70

8x6:
B = 86 mm
L = 50 mm
S = 8 mm
t = 6 mm
d = 12 mm

10x8:
B = 86 mm
L = 50 mm
S = 10 mm
t = 8 mm
d = 15/20 mm

Ref. No.	Designation	Dimensions	Profile	Weight
549 5853	REMAGRIP 70 V/CN	12x2000x10 000 mm	8x6 mm	15.20 kg/m ²
549 5876	REMAGRIP 70 V/CN	15x2000x10 000 mm	10x8 mm	18.48 kg/m ²
549 5886	REMAGRIP 70 V/CN	20x2000x10 000 mm	10x8 mm	25.69 kg/m ²

* (Surface and volume resistivity) < 1x10⁶ Ohm, tested in accordance with DIN EN ISO 284, DIN IEC 93.

** (Fulfills DIN 22100-7 safety requirements (fire safety, hygiene, electrical).)

PULLEY LAGGING

REMAGRIP – High-quality pulley lagging

REMAGRIP 70 HR – The heat resistant universal lagging for heavy-duty operating conditions

REMAGRIP 70 HR has been specially designed as a lagging for drive pulleys in challenging operating conditions with high-temperature environments. It is able to withstand a continuous thermal stress of 90 °C and even short-term stresses of 110 °C.

Properties

- Heat resistant REMAGRIP 70 premium quality
- Reduces slippage between belt and pulley
- Improves and stabilizes coefficient of friction
- Evacuation of moisture and dirt
- Protects the pulley from wear and corrosion
- Prevents material build-up
- Positive influence on belt tracking

- Deep grooving to handle large amounts of dirt and provide long operating life
- CN bonding layer provides fast and good adhesion

Area of application

- Grooved rubber lagging for drive pulleys
- Long belt conveyors
- Large pulley diameters (from 800 mm)
- For high-tension fabric and steel cord belts of all strengths



REMAGRIP 70 HR

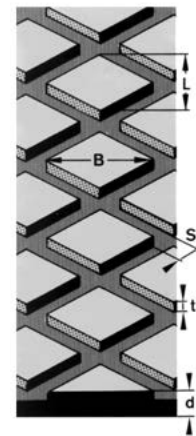

REMAGRIP 70
8x6:
B = 86 mm
L = 50 mm
S = 8 mm
t = 6 mm
d = 12 mm

10x8:
B = 86 mm
L = 50 mm
S = 10 mm
t = 8 mm
d = 15 mm

REMAGRIP 70 HR/CN

Specifications

Polymer basis	BR/IR	DIN ISO 1629
Specific weight	1.11 g/cm ³	DIN EN ISO 1183-1
Hardness	60 Shore A	DIN ISO 7619-1
Profile	8x6 or 10x8 (Profile 50)	
Max. temperature	up to 90 °C, short peaks up to 110 °C	
Colour	Black	

Ref. No.	Designation	Dimensions	Profile	Weight
549 5958	REMAGRIP 70 HR/CN	12x2000x10 000 mm	8x6 mm	12.20 kg/m ²
549 5972	REMAGRIP 70 HR/CN	15x2000x10 000 mm	10x8 mm	14.05 kg/m ²

PULLEY LAGGING

REMAGRIP – High-quality pulley lagging

REMAGRIP 70 – SL strip lagging

REMAGRIP 70 SL strip lagging with diamond pattern and additional longitudinal grooves is used on a global scale. Strips (343 mm wide) can be easily cut to size at the workshop or on-site to fit any required pulley width. REMAGRIP 70 SL is a great alternative to lagging currently available in the market.

Properties

- REMAGRIP 70 premium quality with high abrasion-resistance
- Reduces slippage between belt and pulley
- Improves and stabilizes coefficient of friction
- Evacuation of moisture and dirt
- Protects the pulley from wear and corrosion
- Prevents material build-up
- Positive influence on belt tracking

- Deep grooving to handle large amounts of dirt and provide long operating life
- CN bonding layer provides fast and good adhesion

Area of application

- Grooved rubber lagging for drive pulleys
- Long belt conveyors
- Large pulley diameters (from 800 mm)
- For high-tension fabric and steel cord belts of all strengths



REMAGRIP 70 – SL

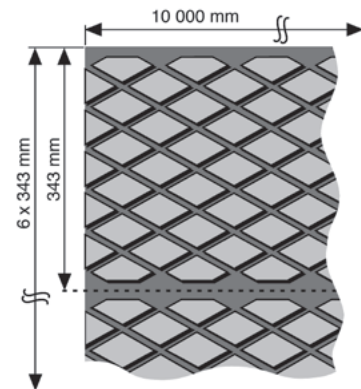

REMAGRIP 70/CN – SL

Can be cut to size for strip lagging of the pulley (also on the equipment). Easy to cut to size with rubber cutting device Type 32 and attachment.

Specifications

Polymer basis	BR/IR/SBR	DIN ISO 1629
Specific weight	1.12 g/cm ³	DIN EN ISO 1183-1
Hardness	62 Shore A	DIN ISO 7619-1
Profile	8 x 6 mm (Profile 50)	
Colour	Black	

Ref. No.	Designation	Dimensions
549 5941	REMAGRIP 70/CN - SL	10 x 2060 x 10 000 mm
549 5893	REMAGRIP 70/CN - SL	12 x 2060 x 10 000 mm
549 6005	REMAGRIP 70/CN - SL	15 x 2060 x 10 000 mm
549 5996	REMAGRIP 70/CN - SL	18 x 2060 x 10 000 mm

PULLEY LAGGING

REMAGRIP – High-quality pulley lagging

REMAGRIP 100 – The lagging for extremely wet operating conditions

REMAGRIP 100 has been specially designed as a lagging for drive pulleys in extremely wet and difficult operating conditions. REMAGRIP 100 offers optimum abrasion-resistance, the knobbed surface enables to handle extreme environments such as wet operating conditions, clay or other smeary materials.

Properties

- Excellent self-cleaning properties
- Good belt tracking even in extremely wet conditions and where there is increased risk of slippage
- Superior wear-resistance
- CN bonding layer provides fast and good adhesion

Area of application

- REMAGRIP 100 for lagging of drive pulleys for light belt conveyors (up to EP 630)
- REMAGRIP 100 HD (heavy-duty) also for medium belt conveyors (up to EP 1250)
- Extremely difficult operating conditions (such as extremely wet conditions, clay or other smeary materials)



REMAGRIP 100

5

REMAGRIP 100/CN

Specifications

Polymer basis	NR/BR	DIN ISO 1629
Specific weight	1.09 g/cm ³	DIN EN ISO 1183-1
Hardness	64 Shore A	DIN ISO 7619-1
Colour	Black	

Ref. No.	Designation	Dimensions	Knob height
539 4340	REMAGRIP 100/CN, Round knob shape	12 x 1470 x 2560 mm	6 mm
539 4333	REMAGRIP 100 HD/CN, Oval knob shape	18 x 300 x 2400 mm	7 mm

PULLEY LAGGING

REMAGRIP – High-quality pulley lagging

REMAGRIP 200 WHITE OIL FOOD

– The lagging for the food processing industry

REMAGRIP 200 WHITE OIL FOOD can be applied as a lagging for non-driven as well as driven pulleys for a variety of wet or dry applications. It fulfills the requirements for food contact and can be applied in any systems with hygiene requirements in accordance with:

- Federal Institute for Risk Assessment, Recommendations on Food Contact Materials XXI, Cat. 3+4 (Germany)
- Regulation (EU) No. 1935/2004
- FDA Regulation No. 21 CFR 177.2600

Properties

- Food quality, oil and grease resistant
- Horizontal grooves ensure excellent evacuation of dirt and easy cleaning
- CN bonding layer provides fast and good adhesion

Area of application

- Special rubber lagging for the food and animal feed industry
- Pulley lagging for rubber and PVC/PVG conveyor belts



REMAGRIP 200 WHITE OIL FOOD

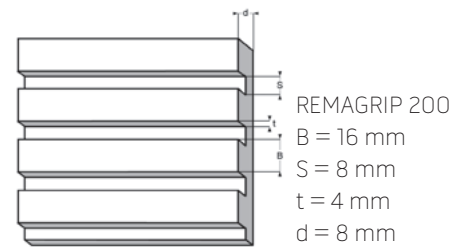

REMAGRIP 200 WHITE OIL FOOD/CN

Specifications

Polymer basis	NBR	DIN ISO 1629
Specific weight	1.22 g/cm ³	DIN EN ISO 1183-1
Hardness	56 Shore A	DIN ISO 7619-1
Colour	White	

Ref. No.	Designation	Dimensions
539 4371	REMAGRIP 200 WHITE OIL FOOD/CN	8 x 1400 x 2500 mm

PULLEY LAGGING

REMAGRIP – High-quality pulley lagging

REMAGRIP CK-X – The premium quality for extreme conditions

The “knobbly” surface of the ceramic tiles provides optimum grip on pulleys subject to high stress. Ceramic material is suitable for pulley lagging, due to its specific properties of extremely high wear-resistance provided by aluminium oxide (Al₂O₃). It replaces traditional materials, because it provides higher profitability by considerably increasing the service life and the efficiency of pulley laggings.



REMAGRIP CK-X

Properties

- Vulcanized Al₂O₃ ceramic tiles
- Single-row ceramic, with knobs
- Highly resistant to wear
- Elastic base made of REMALINE 70 or REMALINE 70 V protects the belt
- Simple and durable affixing with REMA TIP TOP bonding systems

Area of application

- Pulley lagging for pulleys operating under extreme conditions
- For wet, clay-containing, muddy and abrasive materials
- Also for belts under very high tension
- Especially suitable for drive pulleys subject to extreme wear (CK-X)

REMAGRIP CK-X

Al₂O₃ ceramic with knobbed surface.

Specifications

Polymer basis	NR/BR/SBR	DIN ISO 1629
Specific weight	1.12 g/cm ³	DIN EN ISO 1183-1
Hardness	62 Shore A	DIN ISO 7619-1
Colour	Black	

Ref. No.	Designation	Dimensions	Width of ceramic area	For belt width
539 7172	REMAGRIP CK-X 40	15 x 500 x 1250 mm	840 mm	800 mm
539 6990	REMAGRIP CK-X 40 FS	15 x 500 x 1250 mm	920 mm	900 mm
539 6980	REMAGRIP CK-X 45	15 x 500 x 1500 mm	1100 mm	1000 mm
539 7165	REMAGRIP CK-X 50	15 x 500 x 1600 mm	1200 mm	1200 mm
539 6960	REMAGRIP CK-X 50 FS	15 x 500 x 1600 mm	1450 mm	1400 mm
539 7230	REMAGRIP CK-X 60	15 x 500 x 1900 mm	1610 mm	1500 mm
539 7158	REMAGRIP CK-X 70	15 x 500 x 2100 mm	1720 mm	1600 mm
539 7100	REMAGRIP CK-X 70 FS	15 x 500 x 2100 mm	2060 mm	2000 mm

PULLEY LAGGING

REMAGRIP – High-quality pulley lagging

Ref. No.	Designation	Dimensions	Width of ceramic area	For belt width
539 6950	REMAGRIP CK-X 75	15 x 500 x 2300 mm	1880 mm	1800 mm
539 7141	REMAGRIP CK-X 90	15 x 500 x 2500 mm	2060 mm	2000 mm
539 7270	REMAGRIP CK-X 90 FS	15 x 500 x 2500 mm	2420 mm	2400 mm
539 6930	REMAGRIP CK-X 110	15 x 500 x 2880 mm	2420 mm	2400 mm
539 7080	REMAGRIP CK-X 125 FS	15 x 500 x 3250 mm	3100 mm	3000 mm

REMAGRIP CK-X V

REMAGRIP CK-X V is self-extinguishing, antistatic and moderate oil resistant.. It has been specially designed for ATEX operating conditions with high fire regulation or potentially explosive environments such as coal mines or power plants.

Required adhesive system for antistatic rubber coatings: PRIMER PR 200 and CEMENT SC 4000 black/HARDENER ER-42 or CEMENT SC 2000 black/HARDENER UT-R 20.

German underground approval: LOBA No. 18.43.21-89-33.

Polish underground approval: Dopuszczenie WUG Katowice No. B/1724/III/2013

Specifications

Polymer basis	CR	DIN ISO 1629
Specific weight	1.39 g/cm ³	DIN EN ISO 1183-1
Hardness	60 Shore A	DIN ISO 7619-1
Electric resistance	Antistatic*	
Inflammability	Self-extinguishing**	
CN bonding layer	Conductive, black	
Colour	Black	

Ref. No.	Designation	Dimensions	Width of ceramic area	For belt width
539 7250	REMAGRIP CK-X 50 V	15 x 500 x 1600 mm	1200 mm	1200 mm
539 7070	REMAGRIP CK-X 60 V	15 x 500 x 1900 mm	1610 mm	1500 mm
539 7260	REMAGRIP CK-X 70 V	15 x 500 x 2100 mm	1720 mm	1600 mm
539 7220	REMAGRIP CK-X 90 V	15 x 500 x 2500 mm	2060 mm	2000 mm

* (Surface and volume resistivity < 1x10⁶ Ohm, tested in accordance with DIN EN ISO 284, DIN IEC 93.)

** (Fulfills DIN 22100-7 safety requirements (fire safety, hygiene, electrical).)

PULLEY LAGGING

REMAGRIP – High-quality pulley lagging

REMAGRIP CK-X HD (Heavy-Duty) – For continuous grip under heavy-duty conditions

CK-X pulley lagging with 20 mm total lagging thickness. The thicker rubber matrix of REMAGRIP CK-X HD allows more deflection of the tiles under the belt. This property provides additional reserves with extreme belt tensions, especially in combination with fabric belts with high elongation or low cover thickness on the running side.

Ref. No.	Designation	Dimensions	Width of ceramic area	For belt width
539 7167	REMAGRIP CK-X 50 HD	20 x 500 x 1600 mm	1200 mm	1200 mm
539 7160	REMAGRIP CK-X 70 HD	20 x 500 x 2100 mm	1720 mm	1600 mm
539 6955	REMAGRIP CK-X 75 HD	20 x 500 x 2300 mm	1880 mm	1800 mm
539 7271	REMAGRIP CK-X 90 HD FS	20 x 500 x 2500 mm	2420 mm	2400 mm
539 6931	REMAGRIP CK-X 110 HD	20 x 500 x 2880 mm	2420 mm	2400 mm

REMAGRIP CK-X HDX (Extra Heavy-Duty) – For continuous grip under extra heavy-duty conditions

CK-X pulley lagging with 25 mm total lagging thickness. REMAGRIP CK-X HDX is designed to maximum forces in all dimensions. Besides the even thicker rubber base (allows more deformation under the belt) REMAGRIP CK-X HDX features 11 mm thick tiles with a further improved embedding into the rubber matrix. The highly elastic rubber base is optimized for maximum dynamic performance over years. This pulley lagging allows optimum drive force transmission on highest tension belts even under extreme conditions while providing optimum protection for your conveyor belt.

Ref. No.	Designation	Dimensions	Width of ceramic area	For belt width
539 9435	REMAGRIP CK-X 50 HDX	25 x 500 x 1600 mm	1200 mm	1200 mm
539 9450	REMAGRIP CK-X 70 HDX	25 x 500 x 2100 mm	1720 mm	1600 mm
539 9455	REMAGRIP CK-X 75 HDX	25 x 500 x 2300 mm	1880 mm	1800 mm
539 9460	REMAGRIP CK-X 90 HDX	25 x 500 x 2500 mm	2060 mm	2000 mm
539 9480	REMAGRIP CK-X 110 HDX	25 x 500 x 2880 mm	2420 mm	2400 mm

PULLEY LAGGING

REAGRIP – High-quality pulley lagging

REAGRIP CP-X – The benchmark for wear-resistance

The plain surface of the ceramic tiles is highly efficient, particularly on non-drive pulleys (ranging from tail pulleys to snub pulleys) which are subject to high wear.

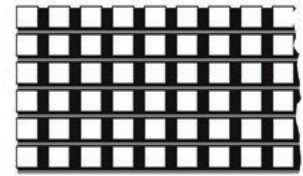

REAGRIP CP-X

Properties

- Vulcanized alumina oxide (Al₂O₃) ceramic tiles
- Single-row ceramic, plain
- Highly resistant to wear
- Elastic base protects the belt
- Simple and durable affixing with REMA TIP TOP bonding systems

Area of application

- Pulley lagging for pulleys operating under extreme conditions
- For wet, clay-containing, muddy and abrasive materials
- Also for very high belt tensions
- For tail pulleys subject to extreme wear
- For **non**-powered drums

REAGRIP CP-X

Specifications

Polymer basis	NR/BR/SBR	DIN ISO 1629
Specific weight	1.12 g/cm ³	DIN EN ISO 1183-1
Hardness	62 Shore A	DIN ISO 7619-1
Colour	Black	

Ref. No.	Designation	Dimensions	Width of ceramic area	For belt width
539 7240	REAGRIP CP-X 60	15 x 500 x 1900 mm	1600 mm	1500 mm
539 7190	REAGRIP CP-X 70	15 x 500 x 2100 mm	1720 mm	1600 mm
539 6940	REAGRIP CP-X 75	15 x 500 x 2300 mm	1880 mm	1800 mm
539 7180	REAGRIP CP-X 90	15 x 500 x 2500 mm	2060 mm	2000 mm

PULLEY LAGGING

REMAGRIP – High-quality pulley lagging

Cover strip CK-X / CP-X

Properties

- CN bonding layer
- Highly elastic
- Wear-resistant

Area of application

- Superior sealing of butt joints for REMAGRIP CK-X and CP-X pulley lagging
- Especially for powdery materials or in critical climates
- Additional protection against infiltration of corrosion

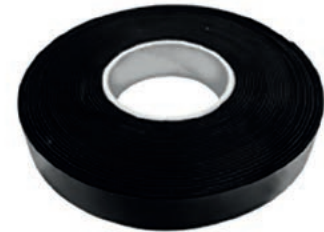

522 0780

5

Cover strip CK-X / CP-X

Ref. No.	Designation	Dimensions	Qty
522 0780	Cover strip CK-X / CP-X	1.5 x 28 x 10 000 mm	5

CN crowning wedge

Properties

- Cost-effective crowning for pulleys
- Improves belt tracking, especially for uneven loading of material

Area of application

- Conveyor belts with fabric plies

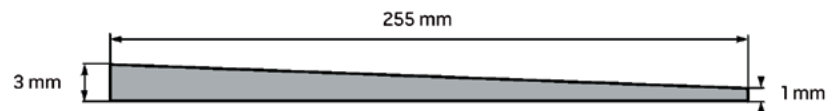

Pulley crowning with CN Crowning wedge and CN Filler rubber

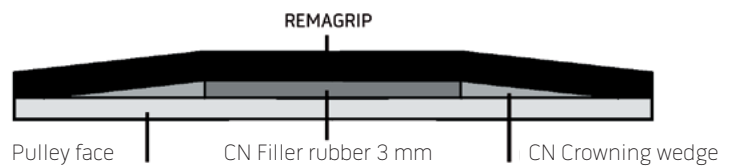

CN crowning wedge

Ref. No.	Designation	Dimensions
528 5545	CN crowning wedge	1/3 x 255 x 2500 mm

PULLEY LAGGING

UNIGRIP – Drum coating material for simple applications

UNIGRIP 60

UNIGRIP 60 can be universally applied as a pulley lagging for simple applications.

Properties

- Reduces slippage between belt and pulley
- Increases and stabilizes the coefficient of friction
- Evacuation of moisture and dirt
- Protects the pulley against wear and corrosion
- Prevents material build-up
- Positive influence on belt tracking
- Wear-resistant material quality

Area of application

- Profile tread for drive pulleys
- For low to averagely loaded textile conveyor belts
- Small pulley diameters (up to 800 mm)

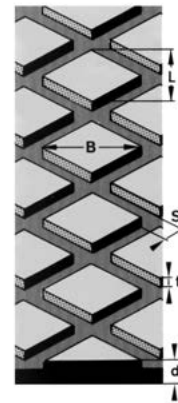

UNIGRIP 60

B = 35 mm

L = 18 mm

S = 6 mm

t = 3 mm

d = 8/10/12 mm

UNIGRIP 60/KS

Specifications

Polymer basis	NR/IR/SBR	DIN ISO 1629
Specific weight	1.18 g/cm ³	DIN EN ISO 1183-1
Hardness	62 Shore A	DIN ISO 7619-1
Colour	Black	

Ref. No.	Designation	Dimensions	Weight
550 3697	UNIGRIP 60/KS	8 x 1400 x 10 000 mm	8.45 kg/m ²
550 3698	UNIGRIP 60/KS	8 x 1600 x 10 000 mm	10.92 kg/m ²
550 3700	UNIGRIP 60/KS	8 x 2000 x 10 000 mm	8.45 kg/m ²
550 3706	UNIGRIP 60/KS	10 x 1400 x 10 000 mm	8.45 kg/m ²
550 3708	UNIGRIP 60/KS	10 x 1600 x 10 000 mm	10.92 kg/m ²
550 3710	UNIGRIP 60/KS	10 x 2000 x 10 000 mm	10.92 kg/m ²
550 3713	UNIGRIP 60/KS	12 x 1400 mm x 10 000 mm	16.98 kg/m ²
550 3716	UNIGRIP 60/KS	12 x 1600 mm x 10 000 mm	16.98 kg/m ²

PULLEY LAGGING

UNIGRIP – Drum coating material for simple applications

UNIGRIP 65

UNIGRIP 65 can be universally applied as a pulley lagging for simple applications.

Properties

- Reduces slippage between belt and pulley
- Increases and stabilizes the coefficient of friction
- Evacuation of moisture and dirt
- Protects the pulley against wear and corrosion
- Prevents material build-up
- Positive influence on belt tracking
- Wear-resistant material quality

Area of application

- Profiled tread for drive pulleys
- For low to medium loading of textile conveyor belts
- For small pulley diameters (up to 800 mm)

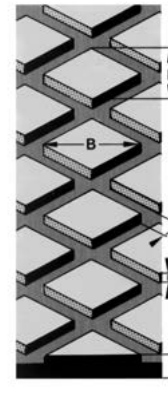

UNIGRIP 65

B = 86 mm

L = 50 mm

S = 6 mm

t = 3 mm

d = 10/12/15 mm

5

UNIGRIP 65/KS

Specifications

Polymer basis	NR/BR/SBR	DIN ISO 1629
Specific weight	1.18 g/cm ³	DIN EN ISO 1183-1
Hardness	62 Shore A	DIN ISO 7619-1
Colour	Black	

Ref. No.	Designation	Dimensions	Weight
550 3715	UNIGRIP 65/KS	10 x 2000 x 10 000 mm	11.68 kg/m ²
550 3720	UNIGRIP 65/KS	12 x 2000 x 10 000 mm	14.22 kg/m ²
550 3730	UNIGRIP 65/KS	15 x 2000 x 10 000 mm	17.89 kg/m ²

PULLEY LAGGING

UNILAG – Pulley lagging for simple applications

UNILAG

UNILAG can be universally applied as a pulley lagging for simple applications.

Properties

- Symmetrical profile – for use in horizontal and vertical directions
- Scrap is reduced to a minimum
- Cost-efficient material
- Evacuation of moisture and dirt
- Protects the pulley against wear and corrosion
- Prevents material build-up
- Positive influence on belt tracking
- Wear-resistant material quality

Area of application

- Grooved rubber lagging for drive pulleys
- For low to medium-loaded fabric belts

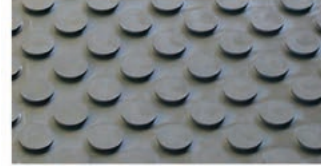

UNILAG
D = 30 mm
t = 5 (4) mm
d = 8/10/12/15 mm

UNILAG/KS

Specifications

Polymer basis	NR/BR/SBR	DIN ISO 1629
Specific weight	1.18 g/cm ³	DIN EN ISO 1183-1
Hardness	62 Shore A	DIN ISO 7619-1
Colour	Black	

Ref. No.	Designation	Dimensions	Weight
550 3636	UNILAG/KS	8 x 2000 x 10 000 mm	6.4 kg/m ²
550 3643	UNILAG/KS	10 x 2000 x 10 000 mm	10.0 kg/m ²
550 3650	UNILAG/KS	12 x 2000 x 10 000 mm	11.64 kg/m ²
550 3667	UNILAG/KS	15 x 2000 x 10 000 mm	15.3 kg/m ²

PULLEY LAGGING

Pulley coating

Pulley coating by means of hot coating or hot casting processes enable a tailor-made protection of the pulley from wear and corrosion perfectly fitted to the particular application and operating condition.



Pulley coating with rubber by means of hot coating process

Properties

- Typical hardness: 45 - 75 Shore A
- Wear-resistant, ATEX-suitable
- Self-extinguishing or low flammability version available on request
- Pulley shape: cylindric or curved
- Profile shape: waffle, diamond and arrowhead pattern or round profile
- Ceramic coating: CK-X "hot", with 15, 20 or 25 mm thickness

Parameters for hot coating

Max. diameter	2700 mm
Max. total length	5700 mm
Max. weight per piece	20 t



5

Pulley coating with PU by means of hot casting process

Properties

- Typical hardness: 60 - 90 Shore A
- Highly wear-resistant, notch-resistant
- Superior mechanical load capability, cut resistant
- Resists hydrolysis
- Pulley shape: cylindric or curved
- Profile shape: waffle, diamond and arrowhead pattern or round profile

Parameters for hot casting process

Max. diameter	1890 mm
Max. total length	4000 mm
Max. weight per piece	10 t
Max. casting weight per piece	650 kg



For detailed information please visit <http://surfaceprotection.rema-tiptop.com>
-or contact your local REMA TIP TOP contact or info@tiptop-elbe.de.



● FEEDING SYSTEMS



REMA TIP TOP



REMASLIDE – Low-friction impact bars

102-104

UNISLIDE – Low-friction impact bars

105

FEEDING SYSTEMS

REMASLIDE – Low-friction impact bars

REMASLIDE impact bars

REMASLIDE impact bars absorb the drop energy of material impact through their proven REMA TIP TOP special rubber substrate. By fully supporting the conveyor belt across the feed points and transfer stations, damage of the belt is avoided.

Properties

- Combination of PE-UHMW (ultra-high molecular weight polyethylene) and REMA TIP TOP special rubber
- Low friction between conveyor belt and REMASLIDE surface Beveled ends of the polyethylene layer to protect the conveyor belt
- Increases operating life of the belt/bar
- Reduction in energy requirement
- Easy and quick mounting by integrated aluminium profile with TT-Fastening Unit type I for bars KG-02, KG-03 and KG-04

- Elastic rubber basis (approx. 40 Shore A)
- Distance between conveyor belt and impact bars must be at least 20 mm (when conveyor belt is not loaded)

Area of application

- Impact protection for conveyor belts at the material feed and transfer points
- Good sealing effect when used in conjunction with REMASKIRT

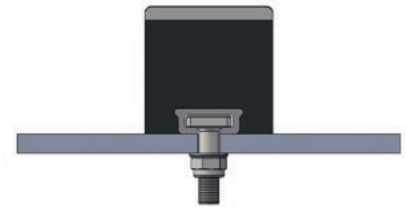

REMASLIDE Low Friction type 02/03/04 with TT-Fastening type I

REMASLIDE Low Friction

- Innovative, low friction sliding surface made of highly wear-resistant PE (10 mm, grey)
- Increases the service life by more than 30 % compared to other standard impact bars
- Recommendation: 4 pieces TT-Fastening Units per metre

Ref. No.	Designation	Dimensions	TT-Fastening Unit
539 0510	REMASLIDE LF KG-02	52x100x1220 mm	I
539 0520	REMASLIDE LF KG-03	80x100x1220 mm	I
539 0530	REMASLIDE LF KG-04	100x100x1220 mm	I

FEEDING SYSTEMS

REMASLIDE – Low-friction impact bars

REMASLIDE V

- Self-extinguishing, antistatic and moderate oil resistance
- Can be used in underground areas
- Highly wear-resistant PUR coat (15 mm, black)
- Elastic rubber basis (approx. 60 Shore A)
- Recommendation: 4 pieces TT-Fastening Units per metre

German underground approval (for rubber compound): LOBA No. 18.43.21-91-24
Polish underground approval (for rubber compound): Dopuszczenie WUG Katowice No. B/1724/III/2013
PUR sliding plate with LOBA approval

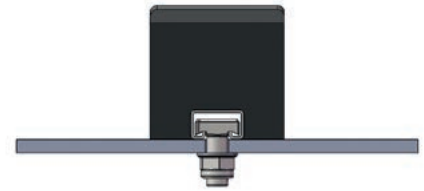

REMASLIDE V with
TT-Fastening Unit type IV

Ref. No.	Designation	Dimensions	TT-Fastening Unit
539 4730	REMASLIDE V KG-02	52x100x1220 mm	IV
539 4740	REMASLIDE V KG-03	80x100x1220 mm	IV
539 4750	REMASLIDE V KG-04	100x100x1220 mm	IV

REMASLIDE ATEX

- Antistatic
- Can be used in ATEX areas
- Low friction surface made of antistatic PE (10 mm, black)
- Elastic rubber basis (approx. 50 Shore A)
- Recommendation: 4 pieces TT-Fastening Units per metre

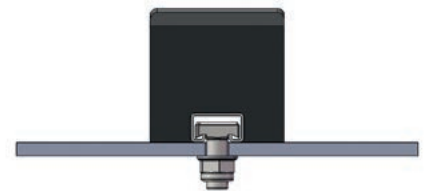

REMASLIDE ATEX with
TT-Fastening Unit type IV

Ref. No.	Designation	Dimensions	TT-Fastening Unit
539 0420	REMASLIDE A KG-02	52x100x1220 mm	IV
539 0440	REMASLIDE A KG-03	80x100x1220 mm	IV
539 0400	REMASLIDE A KG-04	100x100x1220 mm	IV

TT-Fastening Units I

- Torque: 90 Nm
- Consists of forged TT-Fasteners with washer and self-locking nut
- Recommendation: 4 pieces TT-Fastening Units per metre

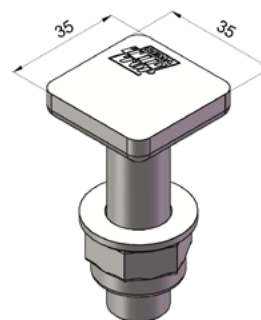

TT-Fastening Units type I

Ref. No.	Designation	Dimensions
539 1006	TT-Fastening Unit I	M 16 x 40 mm
539 1013	TT-Fastening Unit I	M 16 x 60 mm
539 1020	TT-Fastening Unit I	M 16 x 80 mm
539 3610	TT-Fastening Unit I	M 12 x 40 mm
539 3620	TT-Fastening Unit I	M 12 x 60 mm

TT-Fastening Units IV

- Torque: 60 Nm
- Consists of forged TT-Fasteners with washer and self-locking nut
- Recommendation: 4 pieces TT-Fastening Units per metre



TT-Fastening Unit type IV

Ref. No.	Designation	Dimensions
539 3561	TT-Fastening Unit IV	M 16 x 40 mm
539 3468	TT-Fastening Unit IV	M 16 x 60 mm
539 3475	TT-Fastening Unit IV	M 16 x 80 mm
539 3580	TT-Fastening Unit IV	M 12 x 40 mm
539 3590	TT-Fastening Unit IV	M 12 x 60 mm

FEEDING SYSTEMS

UNISLIDE – Low-friction impact bars

UNISLIDE impact bars

UNISLIDE impact bars absorb the drop energy of material impact through their special rubber substrate. By fully supporting the conveyor belt across the feed points and transfer stations, damage of the belt is avoided.

Properties

- Combination of polyethylene (PE) and special rubber
- Beveled ends of the polyethylene layer to protect the conveyor belt
- Easy and quick mounting by integrated steel profile with TT-Fastening Unit type IV
- Distance between conveyor belt and impact bars must be at least 20 mm (when conveyor belt is not loaded)

Area of application

- Impact protection for conveyor belts at the material feed and transfer points
- Good sealing effect when used in conjunction with UNISKIRT

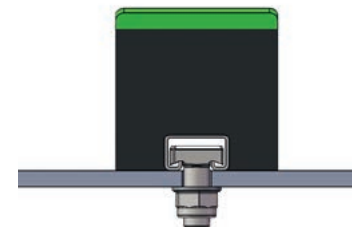

UNISLIDE with TT-Fastening Unit type IV

UNISLIDE

- Surface made of polyethylene (12.5 mm, green)
- Elastic rubber basis (approx. 45 Shore A)
- Recommendation: 4 pieces TT-Fastening Units per metre

Ref. No.	Designation	Dimensions	TT-Fastening Unit
539 9962	UNISLIDE 02	50 x 100 x 1220 mm	IV
539 9963	UNISLIDE 03	75 x 100 x 1220 mm	IV
539 9964	UNISLIDE 04	100 x 100 x 1220 mm	I

● SKIRTING



REMA TIP TOP



REMASKIRT – Skirting rubber

UNISKIRT – Skirting rubber

108-111

112-114

7

SKIRTING

REMASKIRT – Skirting rubber

REMASKIRT 40

High-quality skirting rubber with excellent flexibility and elasticity. Excellent sealing properties particularly in connection with REMASLIDE impact bars.

Properties

- Low friction
- Easy fitment
- Available in thicknesses from 8 to 30 mm and belt widths from 100 to 1800 mm
- Special qualities available on request

- Designed for temperatures from -40 °C to +80 °C

Area of application

- Skirting rubber and scraper for moist material

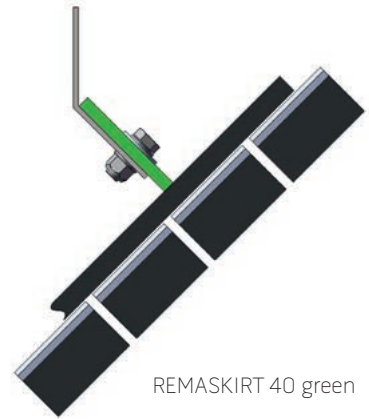

REMASKIRT 40 green

REMASKIRT 40 green

Specifications

Polymer basis	NR	DIN ISO 1629
Specific weight	1.11 g/cm ³	DIN EN ISO 1183-1
Hardness	51 Shore A	DIN ISO 7619-1
Colour	Green*	

Ref. No.	Designation	Dimensions	Ref. No.	Designation	Dimensions
549 6074	REMASKIRT 40	8 x 120 x 10 000 mm	549 6191	REMASKIRT 40	12 x 150 x 10 000 mm
549 6098	REMASKIRT 40	8 x 1800 x 10 000 mm	549 6201	REMASKIRT 40	12 x 200 x 10 000 mm
549 6115	REMASKIRT 40	10 x 100 x 10 000 mm	549 6218	REMASKIRT 40	12 x 1800 x 10 000 mm
549 6122	REMASKIRT 40	10 x 120 x 10 000 mm	549 6249	REMASKIRT 40	15 x 150 x 10 000 mm
549 6139	REMASKIRT 40	10 x 150 x 10 000 mm	549 6256	REMASKIRT 40	15 x 200 x 10 000 mm
549 6146	REMASKIRT 40	10 x 200 x 10 000 mm	549 6280	REMASKIRT 40	15 x 1800 x 10 000 mm
549 6154	REMASKIRT 40	10 x 1800 x 10 000 mm	549 6304	REMASKIRT 40	20 x 150 x 10 000 mm
549 6177	REMASKIRT 40	12 x 100 x 10 000 mm	549 6311	REMASKIRT 40	20 x 200 x 10 000 mm
549 6184	REMASKIRT 40	12 x 120 x 10 000 mm	549 6335	REMASKIRT 40	20 x 1800 x 10 000 mm

* (Please note that this is a product based on natural rubber and therefore deviations in colour may occur.)

SKIRTING

REMASKIRT – Skirting rubber

REMASKIRT 50

High-quality skirting rubber made of natural rubber with high tensile strength. Excellent sealing properties particularly in connection with REMASLIDE impact bars.

Properties

- Low friction
- Easy fitment
- Available in thicknesses from 8 to 30 mm and belt widths from 100 to 1800 mm
- Special qualities available on request

- Designed for temperatures from -40 °C to +80 °C

Area of application

- Skirting rubber and scraper for wet, sticky material



REMASKIRT 50 orange

REMASKIRT 50 orange

Specifications

Polymer basis	NR	DIN ISO 1629
Specific weight	1.11 g/cm ³	DIN EN ISO 1183-1
Hardness	51 Shore A	DIN ISO 7619-1
Colour	Orange*	

Ref. No.	Designation	Dimensions	Ref. No.	Designation	Dimensions
550 1842	REMASKIRT 50	5 x 1800 x 10 000 mm	549 6555	REMASKIRT 50	10 x 1800 x 10 000 mm
549 6438	REMASKIRT 50	6 x 1800 x 10 000 mm	549 6620	REMASKIRT 50	12 x 200 x 10 000 mm
550 1921	REMASKIRT 50	7 x 150 x 10 000 mm	549 6630	REMASKIRT 50	12 x 1800 x 10 000 mm
550 1938	REMASKIRT 50	7 x 1800 x 10 000 mm	549 6641	REMASKIRT 50	15 x 150 x 10 000 mm
549 6476	REMASKIRT 50	8 x 120 x 10 000 mm	549 6658	REMASKIRT 50	15 x 200 x 10 000 mm
549 6500	REMASKIRT 50	8 x 1800 x 10 000 mm	549 6670	REMASKIRT 50	15 x 1800 x 10 000 mm
549 6517	REMASKIRT 50	10 x 100 x 10 000 mm	549 6696	REMASKIRT 50	20 x 150 x 10 000 mm
549 6524	REMASKIRT 50	10 x 120 x 10 000 mm	549 6730	REMASKIRT 50	20 x 1800 x 10 000 mm
549 6531	REMASKIRT 50	10 x 150 x 10 000 mm	549 6737	REMASKIRT 50	25 x 1800 x 10 000 mm
549 6546	REMASKIRT 50	10 x 200 x 10 000 mm	549 6751	REMASKIRT 50	30 x 1800 x 10 000 mm

* (Please note that this is a product based on natural rubber and therefore deviations in colour may occur.)

SKIRTING

REMASKIRT – Skirting rubber

REMASKIRT CB 195

REMASKIRT CB 195 sealing profile with matching mounting rails for your conveyor belt. Excellent sealing properties particularly in connection with REMASLIDE impact bars. The special sealing lips with their labyrinth effect keep transported material on the conveyor belt and reduce contamination and loss of material. The sealing lips are held down on the conveyor belt by their own weight, thus preventing damage.

Properties

- Easy fitment in combination with the mounting rails
- Designed for temperatures from -40 °C to +80 °C
- Self-adjusting sealing lips with labyrinth effect

Area of application

- Skirting rubber seal for conveyor belts transporting fine-grained and dusty material
- Proven especially useful for conveying coal

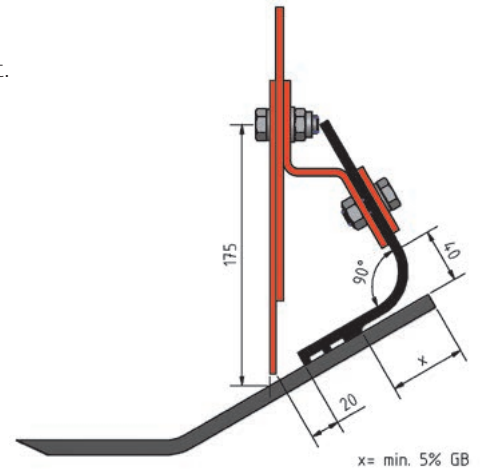

REMASKIRT CB 195

REMASKIRT CB 195

Specifications

Polymer basis	NR/SBR	DIN ISO 1629
Specific weight	1.10 g/cm ³	DIN EN ISO 1183-1
Hardness	63 Shore A	DIN ISO 7619-1
Colour	Black	

Ref. No.	Designation	Dimensions
550 2651	REMASKIRT CB 195	6/10 x 195 x 31 000 mm

Spare and wear parts – REMASKIRT CB 195

Primed and painted red

Ref. No.	Designation	Length	Content
550 2670	Mounting rails CB 195, with screws	1200 mm	2 pcs
550 2660	Mounting rails CB 195, with screws	1200 mm	10 pcs



Mounting rails
REMASKIRT CB 195

SKIRTING

REMASKIRT – Skirting rubber

REMASKIRT CB 195 PUR

REMASKIRT CB 195 PUR sealing profile with matching mounting rails for your conveyor belt. Excellent sealing properties particularly in connection with REMASLIDE impact bars. The special sealing lips with their labyrinth effect keep transported material on the conveyor belt and reduce contamination and loss of material. The sealing lips are held down on the conveyor belt by their own weight, thus preventing damage.



REMASKIRT CB 195 PUR

Properties

- Oil and grease resistant
- Easy fitment in combination with the mounting rails
- Designed for temperatures from -40 °C to +80 °C
- Self-adjusting sealing lips with labyrinth effect

Area of application

- Skirting rubber seal for conveyor belts transporting oil-containing, fine-grained and dusty material
- Proven especially useful for conveying coal
- Especially suitable for use with white conveyor belts

REMASKIRT CB 195 PUR

Specifications

Polymer basis	PUR	DIN ISO 1629
Hardness	55 Shore A	DIN ISO 7619-1
Colour	White	

Ref. No.	Designation	Dimensions
573 5200	REMASKIRT CB 195 PUR	6/10x195x7 000 mm



573 5200

SKIRTING

UNISKIRT – Skirting rubber

UNISKIRT 40

Skirting rubber for easy applications. Excellent sealing properties particularly in connection with UNISLIDE impact bars.

Properties

- Low friction
- Easy fitment
- Available in thicknesses from 6 to 20 mm
- Designed for temperatures from -40 °C to +80 °C

Area of application

- Skirting rubber and scraper for moist, sticky material for non-complex applications



UNISKIRT 40 black

UNISKIRT 40 black

Specifications

Polymer basis	NR/SBR	DIN ISO 1629
Specific weight	1.23 g/cm ³	DIN EN ISO 1183-1
Hardness	45 Shore A	DIN ISO 7619-1
Colour	Black	

Ref. No.	Designation	Dimensions
550 7491	UNISKIRT 40	6 x 2000 x 10 000 mm
550 7081	UNISKIRT 40	8 x 2000 x 10 000 mm
550 7120	UNISKIRT 40	10 x 2000 x 10 000 mm
550 7137	UNISKIRT 40	12 x 2000 x 10 000 mm
550 7144	UNISKIRT 40	15 x 2000 x 10 000 mm
550 7151	UNISKIRT 40	20 x 2000 x 10 000 mm

SKIRTING

UNISKIRT – Skirting rubber

UNISKIRT 40

Skirting rubber for easy applications. Excellent sealing properties particularly in connection with UNISLIDE impact bars.

Properties

- Low friction
- Easy fitment
- Available for belt widths from 100 to 2000 mm
- Designed for temperatures from -40 °C to +80 °C

Area of application

- Skirting rubber and scraper for moist, sticky material for non-complex applications

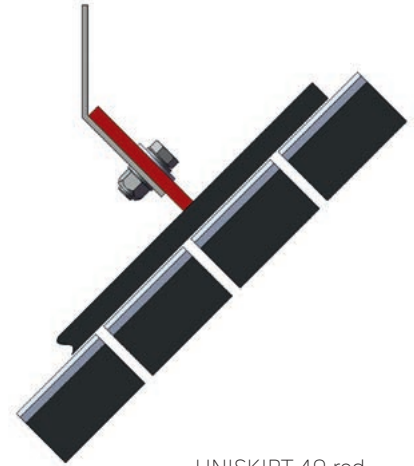

UNISKIRT 40 red

UNISKIRT 40 red

Specifications

Polymer basis	NR/BR/SBR	DIN ISO 1629
Specific weight	1.13 g/cm ³	DIN EN ISO 1183-1
Hardness	45 Shore A	DIN ISO 7619-1
Colour	Red*	

Ref. No.	Designation	Dimensions
550 7600	UNISKIRT 40 RED	10 x 100 x 20 000 mm
550 7610	UNISKIRT 40 RED	10 x 150 x 20 000 mm
550 7620	UNISKIRT 40 RED	10 x 200 x 20 000 mm
550 7630	UNISKIRT 40 RED	10 x 2000 x 20 000 mm

* (Please note that this is a product based on natural rubber and therefore deviations in colour may occur.)

SKIRTING

UNISKIRT – Skirting rubber

UNISKIRT 60

Skirting rubber for easy applications. Excellent sealing properties particularly in connection with UNISLIDE impact bars.

Properties

- Low friction
- Easy fitment
- Available in thicknesses from 6 to 40 mm
- Designed for temperatures from -40 °C to +80 °C

Area of application

- Skirting rubber and scraper for non-complex applications



UNISKIRT 60 black

UNISKIRT 60 black

Specifications

Polymer basis	NR/BR/SBR	DIN ISO 1629
Specific weight	1.20 g/cm ³	DIN EN ISO 1183-1
Hardness	60 Shore A	DIN ISO 7619-1
Colour	Black	

Ref. No.	Designation	Dimensions
550 7510	UNISKIRT 60	6 x 2000 x 10 000 mm
550 7190	UNISKIRT 60	8 x 2000 x 10 000 mm
550 7224	UNISKIRT 60	10 x 2000 x 10 000 mm
550 7231	UNISKIRT 60	12 x 2000 x 10 000 mm
550 7248	UNISKIRT 60	15 x 2000 x 10 000 mm
550 7255	UNISKIRT 60	20 x 2000 x 10 000 mm
550 7262	UNISKIRT 60	25 x 2000 x 10 000 mm
550 7280	UNISKIRT 60	40 x 2000 x 5000 mm

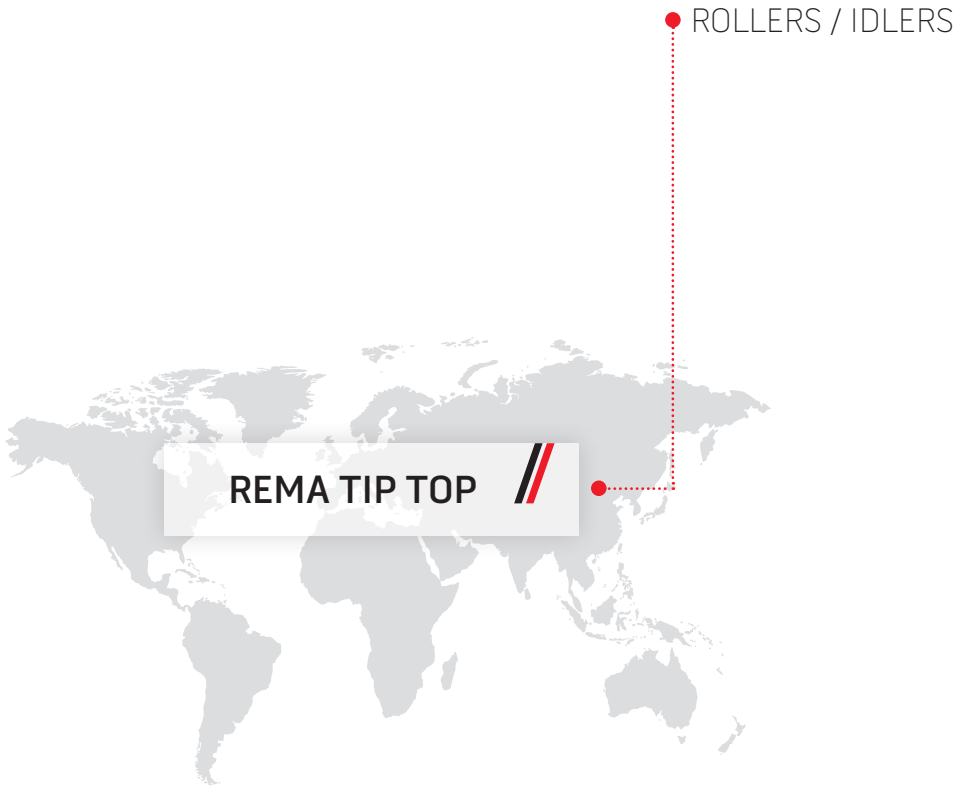

ROLLERS / IDLERS

REMA TIP TOP



REMAROLL – Rollers

116

REMASLEEVE – Belt idler sleeves

117-119

ROLLERS / IDLERS

REMAROLL – Rollers

REMAROLL

REMAROLL HDPE-rollers are extremely long-lasting and for universal use in all conveying systems. Depending on the area of application, the axis can be manufactured with different types of steel and axis ends. The tube, the bearing cases and labyrinth sealings are manufactured entirely from high quality polyethylene. This leads to noise-reduced operation, reduces wear and caking and makes the roller lighter by more than 50% in comparison to traditional steel rollers.



REMAROLL

Properties

- Extremely long-lasting
- Light weight
- Very rigid and highly impact resistant design
- Waterproof and dust resistant
- Belt-friendly
- High noise absorbing capacity
- Maintenance-free, resulting in minimal time needed for inspection and maintenance
- Labyrinth sealings and ball bearings of high quality
- Different roller diameter available from 89 - 159 mm
- Designed for service temperatures from -40 °C to +80 °C and belt speeds up to 4.5 m/s
- A special version for use (ATEX 21) in ATEX Zone 21 is available upon request

Area of application

- Universally applicable for all conveying systems
- Particularly suited the concrete, sand and gravel and recycling industry

Information on the various sizes and profile versions of all items is available on request. A detailed questionnaire is included in the enclosures.

ROLLERS / IDLERS

REMASLEEVE – Belt idler sleeves

REMASLEEVE VSB-RE 25 ORANGE

REMASLEEVE special rubber sleeves for conveyor belt idlers for all common diameters of idlers according to the DIN standard. Quick and easy mounting through pneumatic device.

Properties

- Protection against caking, wear and corrosion
- Extremely elastic
- Excellent self-cleaning properties in wet operation
- CN bonding layer provides fast and long-lasting adhesion

Area of application

- Rubber sleeves for carrying idlers and return idlers

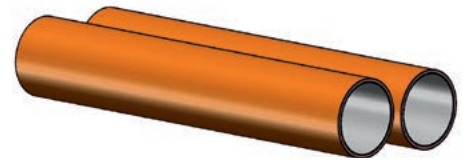

REMASLEEVE VSB-RE 25 ORANGE/CN

REMASLEEVE VSB-RE 25 ORANGE/CN

Specifications

Polymer basis	NR	DIN ISO 1629
Specific weight	0.98 g/cm ³	DIN EN ISO 1183-1
Hardness	31 Shore A	DIN ISO 7619-1
Colour	Orange*	

Ref. No.	Designation	Dimensions
537 1404	REMASLEEVE VSB-RE 25 ORANGE/CN	Ø 2" x 7 x 1300 mm
537 1428	REMASLEEVE VSB-RE 25 ORANGE/CN	Ø 3" x 7 x 1300 mm
537 1459	REMASLEEVE VSB-RE 25 ORANGE/CN	Ø 4" x 7 x 1300 mm
537 1473	REMASLEEVE VSB-RE 25 ORANGE/CN	Ø 5" x 7 x 1300 mm
537 1411	REMASLEEVE VSB-RE 25 ORANGE/CN	Ø 63.5 x 7 x 1300 mm
537 1435	REMASLEEVE VSB-RE 25 ORANGE/CN	Ø 80 x 7 x 1300 mm
537 1442	REMASLEEVE VSB-RE 25 ORANGE/CN	Ø 89 x 7 x 1300 mm
537 1466	REMASLEEVE VSB-RE 25 ORANGE/CN	Ø 108 x 7 x 1300 mm
537 1480	REMASLEEVE VSB-RE 25 ORANGE/CN	Ø 133 x 7 x 1300 mm
537 1497	REMASLEEVE VSB-RE 25 ORANGE/CN	Ø 150 x 7 x 1300 mm

* (Please note that this is a product based on natural rubber and therefore deviations in colour may occur.)

ROLLERS / IDLERS
 REMASLEEVE – Belt idler sleeves

REMASLEEVE VSB-E 40

REMASLEEVE special rubber sleeves for conveyor belt idlers for all common diameters of idlers according to the DIN standard. Quick and easy mounting through pneumatic device.

Properties

- Protection against caking, wear and corrosion
- CN bonding layer provides fast and long-lasting adhesion

Area of application

- Rubber sleeves for carrying idlers and return idlers



REMASLEEVE VSB-E 40/CN

REMASLEEVE VSB-E 40/CN

Specifications

Polymer basis	NR/SBR	DIN ISO 1629
Specific weight	1.02 g/cm ³	DIN EN ISO 1183-1
Hardness	40 Shore A	DIN ISO 7619-1
Colour	Black	

Ref. No.	Designation	Dimensions
537 5280	REMASLEEVE VSB-E 40/CN	Ø 2" x 7 x 1300 mm
537 5314	REMASLEEVE VSB-E 40/CN	Ø 3" x 7 x 1300 mm
537 5345	REMASLEEVE VSB-E 40/CN	Ø 4" x 7 x 1300 mm
537 5376	REMASLEEVE VSB-E 40/CN	Ø 5" x 7 x 1300 mm
537 5022	REMASLEEVE VSB-E 40/CN	Ø 63.5 x 7 x 2750 mm
537 5039	REMASLEEVE VSB-E 40/CN	Ø 80 x 7 x 2750 mm
537 5046	REMASLEEVE VSB-E 40/CN	Ø 89 x 7 x 2750 mm
537 5053	REMASLEEVE VSB-E 40/CN	Ø 108 x 7 x 2750 mm
537 5060	REMASLEEVE VSB-E 40/CN	Ø 133 x 7 x 2750 mm
537 5400	REMASLEEVE VSB-E 40/CN	Ø 150 x 7 x 1300 mm

ROLLERS / IDLERS
 REMASLEEVE – Belt idler sleeves

REMASLEEVE KSB-E 60

REMASLEEVE special rubber sleeves for conveyor belt idlers for all common diameters of idlers according to the DIN standard. Quick and easy mounting through pneumatic device.

Properties

- Protection against corrosion and wear
- Cost-effective tubing sleeve for protection against corrosion
- CN bonding layer provides fast and long-lasting adhesion

Area of application

- Rubber sleeves for carrying idlers and return idlers



REMASLEEVE KSB-E 60/CN

REMASLEEVE KSB-E 60/CN

Specifications

Polymer basis	NR/BR/SBR	DIN ISO 1629
Specific weight	1.12 g/cm ³	DIN EN ISO 1183-1
Hardness	62 Shore A	DIN ISO 7619-1
Colour	Black	

Ref. No.	Designation	Dimensions
537 3206	REMASLEEVE KSB-E 60/CN	∅ 50 x 4 x 1300 mm
537 5125	REMASLEEVE KSB-E 60/CN	∅ 63.5 x 4 x 2750 mm
537 5132	REMASLEEVE KSB-E 60/CN	∅ 80 x 4 x 2750 mm
537 5149	REMASLEEVE KSB-E 60/CN	∅ 89 x 4 x 2750 mm
537 5156	REMASLEEVE KSB-E 60/CN	∅ 108 x 4 x 2750 mm
537 5163	REMASLEEVE KSB-E 60/CN	∅ 133 x 4 x 2750 mm

ROLLERS / IDLERS REMASLEEVE – Belt idler sleeves

Accessories – REMASLEEVE VSB / KSB

For quick and easy pneumatic mounting of the belt idler sleeves.

Ref. No.	Designation	Dimensions
596 7478	Mounting set VSB/KSB includes 1x mounting adapter (idler Ø 50/63.5/80/89/108/133/150 mm), 1x fastening strap, 1x pedal-operated air injection device with flexible hose	
595 2470	Mounting adapter VSB/KSB	Ø 50 mm
595 2421	Mounting adapter VSB/KSB	Ø 63.5 mm
595 2438	Mounting adapter VSB/KSB	Ø 80 mm
595 2445	Mounting adapter VSB/KSB	Ø 89 mm
595 2469	Mounting adapter VSB/KSB	Ø 108 mm
595 2483	Mounting adapter VSB/KSB	Ø 133 mm
595 2490	Mounting adapter VSB/KSB	Ø 150 mm

BELT CLEANING SYSTEMS



REMA TIP TOP



REMACLEAN – Scraper Rubber	122-127
REMACLEAN – Belt Scraper	128-136
REMACLEAN – Tension Unit	137-139
REMACLEAN – F-Series – for use on pulley	140-149
REMACLEAN – F-Series – for use on pulley in large conveyor systems	150-152
REMACLEAN – U-Series – for use on belt	153-170
REMACLEAN – Belt Cleaning Brushes	171-177
REMACLEAN – Belt Return Side Scraper	178-181

BELT CLEANING SYSTEMS

REMACLEAN – Scraper Rubber

REMACLEAN 60

Due to its excellent abrasion-resistance and high elasticity, our special rubber material REMACLEAN 60 is capable of significantly prolonging service life compared to conventional rubber materials. The scraper rubber is mounted on the system's existing scraper system and when new may protrude from the bracket by up to its own thickness.



REMACLEAN 60

Properties

- Excellent wear-resistance
- Very high flexibility
- Low friction on conveyor belt
- Easy fitment
- Different thicknesses available from 8 - 20 mm
- Widths up to 1800 mm available
- Designed for service temperatures from -40 °C to +70 °C

Area of application

- Universally applicable as scraper and skirting rubber for granulated, non-sticky material

REMACLEAN 60

Specifications

Polymer basis	BR/IR/SBR	DIN ISO 1629
Specific weight	1.13 g/cm ³	DIN EN ISO 1183-1
Hardness	60 Shore A	DIN ISO 7619-1
Colour	Black	

Ref. No.	Designation	Dimensions
549 7035	REMACLEAN 60	8 x 1800 x 10 000 mm
549 7091	REMACLEAN 60	10 x 1800 x 10 000 mm
549 7138	REMACLEAN 60	15 x 1800 x 10 000 mm
549 7183	REMACLEAN 60	20 x 1800 x 10 000 mm

BELT CLEANING SYSTEMS

REMACLEAN – Scraper Rubber

REMACLEAN 60 MOR

Especially for moderately oil resistant conveyor belts with fabric plies used in the recycling industry. Roll can be cut into strips upon request.



REMACLEAN 60 MOR

Properties

- Good wear-resistance
- Very high flexibility
- Low friction on conveyor belt
- Different thicknesses available from 5 - 10 mm
- Widths up to 2000 mm available
- Designed for service temperatures from -40 °C to +70 °C
- Moderate oil and grease resistant

Area of application

- Universally applicable as scraper and skirting rubber for granulated, nonsticky material in the recycling industry

REMACLEAN 60 MOR

Specifications

Polymer basis	NBR/SBR	DIN ISO 1629
Specific weight	1.14 g/cm ³	DIN EN ISO 1183-1
Hardness	63 Shore A	DIN ISO 7619-1
Colour	Black	

Ref. No.	Designation	Dimensions	Weight
549 7520	REMACLEAN 60 MOR	5 x 2000 x 10 000 mm	11.97 kg/m
549 7530	REMACLEAN 60 MOR	7 x 2000 x 10 000 mm	16.76 kg/m
549 7540	REMACLEAN 60 MOR	10 x 2000 x 10 000 mm	23.94 kg/m

BELT CLEANING SYSTEMS

REMACLEAN – Scraper Rubber

REMACLEAN 70

Due to its excellent abrasion-resistance and high elasticity, our special rubber material REMACLEAN 70 is perfectly suitable to achieve significantly longer service life compared to conventional rubber materials. The scraper rubber is mounted on the system's existing scraper system and when new may protrude from the bracket by up to its own thickness.

Properties

- Excellent wear-resistance
- Very high flexibility
- Low friction on conveyor belt
- Easy fitment
- Different thicknesses available from 6 - 20 mm
- Widths up to 2000 mm available
- Designed for service temperatures from -40 °C to +70 °C

Area of application

- Universally applicable as scraper and skirting rubber for granulated, non-sticky material



REMACLEAN 70

REMACLEAN 70

Roll can be cut into strips upon request.

Specifications

Polymer basis	NR/BR	DIN ISO 1629
Specific weight	1.09 g/cm ³	DIN EN ISO 1183-1
Hardness	63 Shore A	DIN ISO 7619-1
Colour	Black	

Ref. No.	Designation	Dimensions	Weight
549 9200	REMACLEAN 70	6 x 2000 x 10 000 mm	13.86 kg/m
549 6815	REMACLEAN 70	10 x 120 x 10 000 mm	1.39 kg/m
549 6822	REMACLEAN 70	10 x 150 x 10 000 mm	1.73 kg/m
549 6839	REMACLEAN 70	10 x 2000 x 10 000 mm	23.00 kg/m
549 6860	REMACLEAN 70	15 x 200 x 10 000 mm	3.45 kg/m
549 6884	REMACLEAN 70	15 x 2000 x 10 000 mm	34.50 kg/m
549 6925	REMACLEAN 70	20 x 2000 x 10 000 mm	46.00 kg/m

BELT CLEANING SYSTEMS

REMACLEAN – Scraper Rubber

REMACLEAN 70 V

Self-extinguishing, antistatic and moderate oil resistance.

German underground approval: 18.43.21-91-4

Polish underground approval: Dopuszczenie WUG Katowice No. B/1724/III/2013

May be used in ATEX installations.

Properties

- Very high flexibility
- Low friction on conveyor belt
- Easy fitment
- Different thicknesses available from 8 - 20 mm
- Widths up to 2000 mm available

Area of application

- Universally applicable as scraper and skirting rubber



REMACLEAN 70 V

REMACLEAN 70 V

Roll can be cut into strips upon request.

Specifications

Polymer basis	CR	DIN ISO 1629
Specific weight	1.40 g/cm ³	DIN EN ISO 1183-1
Hardness	60 Shore A	DIN ISO 7619-1
Colour	Black	

Ref. No.	Designation	Dimensions	Weight
549 7333	REMACLEAN 70 V	8 x 2000 x 10 000 mm	23.52 kg/m
549 7388	REMACLEAN 70 V	10 x 2000 x 10 000 mm	29.20 kg/m
549 7436	REMACLEAN 70 V	15 x 2000 x 10 000 mm	43.80 kg/m
549 7474	REMACLEAN 70 V	20 x 2000 x 10 000 mm	58.40 kg/m

BELT CLEANING SYSTEMS

REMACLEAN – Scraper Rubber

REMACLEAN CAB GREEN

Three-ply combi scraping rubber (CAB) with wear-resistant outer layer and elastic inner layer. The combi scraper rubber may protrude from its support up to 1.5 times its thickness.

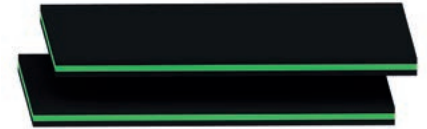

REMACLEAN CAB GREEN

Properties

- Excellent wear-resistance
- Very belt-friendly
- Low friction on conveyor belt
- Different thicknesses available from 15 - 40 mm
- Widths up to 2000 mm available

- Designed for service temperatures from -40 °C to +70 °C

Area of application

- Universally applicable as scraper for granular, slightly sticky and moist material

REMACLEAN CAB GREEN

Roll can be cut into strips upon request.

Specifications

Polymer basis	NR/BR	DIN ISO 1629
Specific weight	1.21 g/cm ³	DIN EN ISO 1183-1
Hardness	69/51/69 Shore A	DIN ISO 7619-1
Colour	Black/Green/Black	

Ref. No.	Designation	Dimensions	Weight
549 8411	REMACLEAN CAB GREEN	15x100x10 000 mm	1.81 kg/m
549 8428	REMACLEAN CAB GREEN	15x120x10 000 mm	2.17 kg/m
549 8435	REMACLEAN CAB GREEN	15x150x10 000 mm	2.73 kg/m
549 8442	REMACLEAN CAB GREEN	15x2000x10 000 mm	36.29 kg/m
549 8459	REMACLEAN CAB GREEN	20x100x10 000 mm	2.38 kg/m
549 8473	REMACLEAN CAB GREEN	20x150x10 000 mm	3.57 kg/m
549 8497	REMACLEAN CAB GREEN	20x2000x10 000 mm	47.56 kg/m
549 8514	REMACLEAN CAB GREEN	25x120x10 000 mm	3.51 kg/m
549 8521	REMACLEAN CAB GREEN	25x150x10 000 mm	4.39 kg/m
549 8538	REMACLEAN CAB GREEN	25x200x10 000 mm	5.84 kg/m
549 8552	REMACLEAN CAB GREEN	25x2000x10 000 mm	58.43 kg/m
549 8624	REMACLEAN CAB GREEN	30x2000x10 000 mm	68.88 kg/m
549 8648	REMACLEAN CAB GREEN	40x2000x5000 mm	91.84 kg/m

BELT CLEANING SYSTEMS

REMACLEAN – Scraper Rubber

REMACLEAN CAB GREY

Three-ply combi scraping rubber (CAB) with wear-resistant outer layer and elastic inner layer. The combi scraper rubber may protrude from its support up to 1.5 times its thickness.



REMACLEAN CAB GREY

Properties

- Excellent wear-resistance
- Very belt-friendly
- Low friction on conveyor belt
- Different thicknesses available from 15 - 30 mm
- Widths up to 2000 mm available
- Designed for service temperatures from -40 °C to +70 °C

Area of application

- Universally applicable as scraper for granular, slightly sticky and moist material

REMACLEAN CAB GREY

Roll can be cut into strips upon request.

Specifications

Polymer basis	BR/NR/IR	DIN ISO 1629
Specific weight	1.23/1.08/1.23 g/cm ³	DIN EN ISO 1183-1
Hardness	81/48/81 Shore A	DIN ISO 7619-1
Colour	Black/Grey/Black	

Ref. No.	Designation	Dimensions	Weight
549 9283	REMACLEAN CAB GREY	15 x 150 x 10 000 mm	2.81 kg/m
549 9300	REMACLEAN CAB GREY	15 x 2000 x 10 000 mm	37.50 kg/m
549 9317	REMACLEAN CAB GREY	20 x 100 x 10 000 mm	2.50 kg/m
549 9331	REMACLEAN CAB GREY	20 x 150 x 10 000 mm	3.75 kg/m
549 9355	REMACLEAN CAB GREY	20 x 2000 x 10 000 mm	50.00 kg/m
549 9379	REMACLEAN CAB GREY	25 x 120 x 10 000 mm	3.47 kg/m
549 9386	REMACLEAN CAB GREY	25 x 150 x 10 000 mm	4.58 kg/m
549 9410	REMACLEAN CAB GREY	25 x 250 x 10 000 mm	5.8 kg/m
549 9434	REMACLEAN CAB GREY	25 x 2000 x 10 000 mm	61.00 kg/m
549 9506	REMACLEAN CAB GREY	30 x 2000 x 10 000 mm	72.00 kg/m

BELT CLEANING SYSTEMS

REMACLEAN – Belt Scraper

REMACLEAN KWA

Highly abrasion-resistant KWA rubber scraper bar for universal use with a rigid steel construction. Recommended to be fitted with tensioning device type INNOVATION, PRECISION or STANDARD.

Properties

- High-performance scraper which protects the belt
- Long service life due to wear-resistant REMA TIP TOP rubber quality
- Excellent cost-performance-ratio
- Three subsequently-usable scraper bars
- Easy fitment
- Designed for service temperatures from -40 °C to +80 °C and belt speeds up to 3.5 m/s
- Also suited for use with mechanical joints

Area of application

- Particularly suited for pre-cleaning
- Universally applicable to many types of materials such as moist sand and gravel, hard coal, clay, refuse and fat-containing material



REMACLEAN KWA

REMACLEAN KWA

Specifications

Polymer basis	NR/BR	DIN ISO 1629
Specific weight	1.10 g/cm ³	DIN EN ISO 1183-1
Hardness	64 Shore A	DIN ISO 7619-1
Colour	Black	

Ref. No.	Designation	Belt width
578 7012	REMACLEAN KWA	500 mm
578 7029	REMACLEAN KWA	650 mm
578 7036	REMACLEAN KWA	800 mm
578 7043	REMACLEAN KWA	1000 mm
578 7050	REMACLEAN KWA	1200 mm
578 7270	REMACLEAN KWA	1400 mm
578 7407	REMACLEAN KWA	1600 mm

* (Other belt widths on request.)

BELT CLEANING SYSTEMS

REMACLEAN – Belt Scraper

REMACLEAN KWA V

Highly abrasion-resistant KWA rubber scraper bar for universal use with a rigid steel construction. V quality is self-extinguishing, antistatic and moderately oil resistant and therefore particularly suitable for underground mining and for oil-containing conveyor goods. Recommended to be fitted with tensioning device type INNOVATION, PRECISION or STANDARD.

German underground approval: LOBA No. 18.43.21-91-24

Polish underground approval: Dopuszczenie WUG Katowice No. B/1724/III/2013

Properties

- High-performance scraper which protects the belt
- Long service life due to wear-resistant rubber quality
- Excellent cost-performance-ratio
- Three subsequently-usable scraper bars
- Easy fitment
- Designed for service temperatures from -40 °C to +80 °C and belt speeds up to 3.5 m/s
- Suited for use with mechanical joints

Area of application

- Particularly suited for pre-cleaning
- Universally applicable to many types of materials such as moist sand and gravel, hard coal, clay, refuse and fat-containing material



REMACLEAN KWA V

REMACLEAN KWA V

Specifications

Polymer basis	CR	DIN ISO 1629
Specific weight	1.39 g/cm ³	DIN EN ISO 1183-1
Hardness	60 Shore A	DIN ISO 7619-1
Colour	Black	

Ref. No.	Designation	Belt width
578 7225	REMACLEAN KWA V	650 mm
578 7232	REMACLEAN KWA V	800 mm
578 7249	REMACLEAN KWA V	1000 mm
578 7256	REMACLEAN KWA V	1200 mm
578 7263	REMACLEAN KWA V	1400 mm
578 7311	REMACLEAN KWA V	1600 mm

BELT CLEANING SYSTEMS

REMACLEAN – Belt Scraper

REMACLEAN KWA PUR

Highly abrasion-resistant polyurethane KWA scraper bar for universal use with a rigid steel construction (special version with stainless steel construction available on request). EU quality is antistatic and resistant to hydrolysis and therefore particularly suitable for water-containing conveyor goods. Recommended to be fitted with tensioning device type INNOVATION, PRECISION or STANDARD.



REMACLEAN KWA PUR

Properties

- High-performance scraper which protects the belt
- Long service life due to wear-resistant REMA TIP TOP PUR quality
- Excellent cost-performance-ratio
- Three subsequently-usable scraper bars
- Easy fitment
- Designed for service temperatures from $-30\text{ }^{\circ}\text{C}$ to $+70\text{ }^{\circ}\text{C}$ and belt speeds up to 3.5 m/s
- Suited for use with mechanical joints

Area of application

- Particularly suited for pre-cleaning, moderately useable for fine cleaning
- Universally applicable to many types of materials such as moist sand and gravel, hard coal, lignite, clay, cement and gypsum

REMACLEAN KWA PUR

Specifications

Polymer basis	PUR	DIN ISO 1629
Hardness	90 Shore A	DIN ISO 7619-1
Colour	Brown	

Ref. No.	Designation	Belt width
578 7840	REMACLEAN KWA PUR	500 mm
578 7850	REMACLEAN KWA PUR	650 mm
578 7860	REMACLEAN KWA PUR	800 mm
578 7870	REMACLEAN KWA PUR	1000 mm
578 7880	REMACLEAN KWA PUR	1200 mm
578 7890	REMACLEAN KWA PUR	1400 mm
578 7900	REMACLEAN KWA PUR	1600 mm

BELT CLEANING SYSTEMS

REMACLEAN – Belt Scraper

REMACLEAN PUR

Highly abrasion-resistant polyurethane scraper bar for universal use with a rigid steel construction (special version with stainless steel construction available on request). EU quality is antistatic and resistant to hydrolysis and therefore particularly suitable for water-containing conveyor goods. Recommended to be fitted with tensioning device type INNOVATION, PRECISION or STANDARD.



REMACLEAN PUR

Properties

- High-performance scraper which protects the belt
- Long service life due to wear-resistant REMA TIP TOP PUR quality
- Excellent cost-performance-ratio
- Two subsequently-usable scraper bars
- Easy fitment
- Designed for service temperatures from -30 °C to $+70\text{ °C}$ and belt speeds up to 3.5 m/s
- Also suited for use with mechanical joints

Area of application

- Particularly suited for pre-cleaning, moderately useable for fine cleaning
- Universally applicable to many types of materials such as moist sand and gravel, hard coal, lignite, clay, cement, gypsum, refuse and fat-containing material

REMACLEAN PUR

Specifications

Polymer basis	PUR	DIN ISO 1629
Hardness	90 Shore A	DIN ISO 7619-1
Colour	Brown	

Ref. No.	Designation	Belt width
578 7500	REMACLEAN PUR	500 mm
578 7517	REMACLEAN PUR	650 mm
578 7524	REMACLEAN PUR	800 mm
578 7531	REMACLEAN PUR	1000 mm
578 7548	REMACLEAN PUR	1200 mm
578 7555	REMACLEAN PUR	1400 mm
578 7562	REMACLEAN PUR	1600 mm

BELT CLEANING SYSTEMS

REMACLEAN – Belt Scraper

REMACLEAN PUR LIGHT

Highly abrasion-resistant polyurethane scraper bar for universal use with a rigid, weight reduced steel construction (special version with stainless steel construction available on request). Recommended to be fitted with tensioning device type INNOVATION, PRECISION or STANDARD.

Properties

- High-performance scraper which protects the belt in lightweight version
- Long service life due to wear-resistant REMA TIP TOP PUR quality
- Excellent cost-performance-Ratio
- Two subsequently-usable scraper bars
- Easy fitment
- Designed for service temperatures from -30 °C to +70 °C and belt speeds up to 2.5 m/s

Area of application

- Particularly suited for pre-cleaning as well as main cleaner for dry materials
- Universally applicable to many types of materials such as moist sand and gravel, hard coal, lignite, clay, cement, gypsum, refuse and fat-containing material

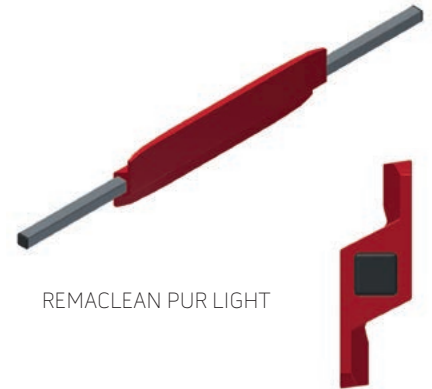

REMACLEAN PUR LIGHT

REMACLEAN PUR LIGHT

Specifications

Polymer basis	PUR	DIN ISO 1629
Hardness	64 Shore A	DIN ISO 7619-1
Colour	Red	

Ref. No.	Designation	Belt width
578 7430	REMACLEAN PUR LIGHT	400 mm
578 7440	REMACLEAN PUR LIGHT	500 mm
578 7450	REMACLEAN PUR LIGHT	650 mm
578 7460	REMACLEAN PUR LIGHT	800 mm
578 7470	REMACLEAN PUR LIGHT	1000 mm
578 7480	REMACLEAN PUR LIGHT	1200 mm
578 7490	REMACLEAN PUR LIGHT	1400 mm

BELT CLEANING SYSTEMS

REMACLEAN – Belt Scraper

REMACLEAN C

Highly abrasion-resistant rubber scraper bar for universal use with ceramic material flexibly embedded in rubber and a rigid steel construction.
Belt-friendly cleaning due to rounded outer ceramic elements.

Properties

- High-performance scraper which protects the belt
- Long service life due to wear-resistant REMA TIP TOP rubber quality
- Excellent cost-performance-ratio
- Easy fitment
- Designed for service temperatures from -40 °C to +80 °C and belt speeds up to 3.5 m/s
- Not suited for use with mechanical joints

Area of application

- Particularly suited for pre-cleaning and just as well suited as main cleaner
- Universally applicable to many types of materials such as hard coal, lignite, clay, cement, gypsum, refuse and sticky material with a high water content
- Less suited for material containing quartz and fat



REMACLEAN C

REMACLEAN C

Specifications

Polymer basis	NR/BR	DIN ISO 1629
Hardness	64 Shore A	DIN ISO 7619-1
Colour	Black	

Ref. No.	Designation	Belt width
578 7593	REMACLEAN C	400 mm
578 7603	REMACLEAN C	500 mm
578 7610	REMACLEAN C	650 mm
578 7627	REMACLEAN C	800 mm
578 7634	REMACLEAN C	1000 mm
578 7641	REMACLEAN C	1200 mm
578 8640	REMACLEAN C	1400 mm
578 7665	REMACLEAN C	1600 mm

BELT CLEANING SYSTEMS

REMACLEAN – Belt Scraper

REMACLEAN M

Highly abrasion-resistant rubber scraper bar for universal use with tungsten carbide inserts flexibly embedded in rubber and a rigid steel construction. Belt-friendly cleaning due to rounded outer carbide inserts. Recommended to be fitted with tensioning device type INNOVATION.



REMACLEAN M

Properties

- High-performance scraper which protects the belt
- Long service life due to wear-resistant REMA TIP TOP rubber quality
- Excellent cost-performance-ratio
- Easy fitment
- Designed for service temperatures from -40 °C to +80 °C and belt speeds up to 3.5 m/s
- Not suited for use with mechanical joints

Area of application

- Particularly suited for pre-cleaning and just as well suited as main cleaner
- Universally applicable to many types of materials such as moist sand and gravel, hard coal, lignite, clay, cement, gypsum, refuse and extremely sticky and abrasive material
- Less suited for material containing fat

REMACLEAN M

Specifications

Polymer basis	NR/BR	DIN ISO 1629
Hardness	64 Shore A	DIN ISO 7619-1
Colour	Black	

Ref. No.	Designation	Belt width
578 9010	REMACLEAN M	500 mm
578 9027	REMACLEAN M	600 mm
578 9041	REMACLEAN M	800 mm
578 9072	REMACLEAN M	1000 mm
578 9096	REMACLEAN M	1200 mm
578 9106	REMACLEAN M	1400 mm
578 9120	REMACLEAN M	1600 mm

BELT CLEANING SYSTEMS

REMACLEAN – Belt Scraper

REMACLEAN HML

Highly wear-resistant, universally usable scraper bar made from carbide with a non-stick coating and a robust steel system carrier. A special version in stainless or galvanised steel is also available. Recommended to be fitted with tensioning device type INNOVATION.

Properties

- High-performance scraper which protects the belt
- Long service life due to the high-quality carbide plates
- Requires very little contact pressure due to very small carbide surface area
- Easy fitment
- Designed for service temperatures from $-40\text{ }^{\circ}\text{C}$ to $+80\text{ }^{\circ}\text{C}$ (special versions up to $+120\text{ }^{\circ}\text{C}$ available) and belt speeds up to 4.0 m/s
- Not suited for use with mechanical joints

Area of application

- Particularly suited for pre-cleaning and just as well suited as main cleaner
- Universally applicable to many types of materials such as moist sand and gravel, hard coal, lignite, clay, cement, gypsum, refuse and very quartz-rich, sticky and abrasive material



REMACLEAN HML

REMACLEAN HML

Ref. No.	Designation	Belt width
578 2010	REMACLEAN HML	400 mm
578 2020	REMACLEAN HML	500 mm
578 2030	REMACLEAN HML	650 mm
578 2040	REMACLEAN HML	800 mm
578 2060	REMACLEAN HML	1000 mm
578 2070	REMACLEAN HML	1200 mm

BELT CLEANING SYSTEMS

REMACLEAN – Tension Unit

REMACLEAN STANDARD

Tension unit for universal use with torsion element and support arm with adjustable angle for optimum inspection and servicing of the system. Extremely long service life. Vibration absorbing and flexible due to integrated rubber spring elements. Can be retrofitted with reversing stop that can also be used as a buffer for the support arm.

Properties

- Extremely long-lasting
- Easy fitting – can also retroactively be fitted to all conveyor belt systems with minimal effort
- Quick and easy scraper bar exchange
- Consistent cleaning performance through consistent contact pressure
- Low design height
- Maintenance-free, resulting in minimal time needed for inspection and maintenance

- Designed for service temperatures from –40 °C to +80 °C, belt speeds up to 3.5 m/s and belt widths from 400 to 1600 mm
- Suited for use with mechanical joints

Area of application

- Particularly suited for scraper bars made from rubber or Polyurethane with square support tubes such as REMACLEAN KWA/PUR



REMACLEAN STANDARD

REMACLEAN STANDARD

Ref. No.	Designation	For belt width	Content
578 8389	REMACLEAN STANDARD includes 2x tensioning devices SE 27, 2x holders SE 27, screws	400 - 800 mm	1 pair
578 8406	Tensioning device SE 27		1 piece
578 8420	Holder SE 27		1 piece
578 8396	REMACLEAN STANDARD includes 2x tensioning devices SE 38, 2x holders SE 38, screws	1000 - 1600 mm	1 pair
578 8413	Tensioning device SE 38		1 piece
578 8437	Holder SE 38		1 piece

BELT CLEANING SYSTEMS

REMACLEAN – Tension Unit

REMACLEAN PRECISION

Tension unit for universal use with torsion element and support arm with pivoting mechanism for precise 90° adjustment of the scraper to the belt as well as an scale for setting the contact pressure for optimum inspection and servicing of the system. Extremely long service life. Vibration absorbing and flexible due to integrated rubber spring elements. Can be retrofitted with reversing stop that can also be used as a buffer for the support arm.

Properties

- Extremely long-lasting
- Quick and easy scraper bar exchange
- Consistent cleaning performance through consistent contact pressure
- Low design height
- Maintenance-free, resulting in minimal time needed for inspection and maintenance
- Designed for service temperatures from -40 °C to +80 °C, belt speeds up to 3.5 m/s and belt widths from 400 to 1800 mm
- Suited for use with mechanical joints

Area of application

- Particularly suited for scraper bars made from rubber or polyurethane with square support tubes such as REMACLEAN KWA/PUR/C/M

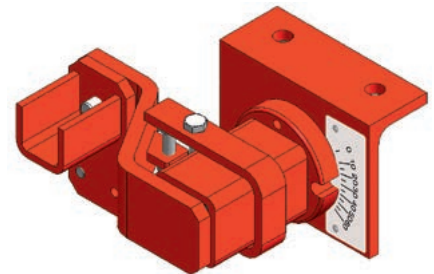

REMACLEAN PRECISION

REMACLEAN PRECISION

Ref. No.	Designation	For belt width	Content
578 8310	REMACLEAN PRECISION	400 - 800 mm	1 pair
578 8341	REMACLEAN PRECISION	1000 mm	1 pair
578 8358	REMACLEAN PRECISION	1200 - 1800 mm	1 pair

BELT CLEANING SYSTEMS

REMACLEAN – Tension Unit

REMACLEAN INNOVATION

Tension unit for universal use with torsion element and support arm with pivoting mechanism for precise 90° adjustment of the scraper to the belt as well as scale for setting the contact pressure for optimum inspection and servicing of the system. The contact pressure can be continuously adjusted* using a tension spindle (display for adjustment included). Extremely long service life. Vibration absorbing and flexible due to integrated rubber spring elements. Can be retrofitted with reversing stop that can also be used as a buffer for the support arm.

Properties

- Extremely long-lasting
- Easy fitting – can also retroactively be fitted to all conveyor belt systems with minimal effort
- Quick and easy scraper bar exchange
- Consistent cleaning performance through consistent contact pressure
- Low design height, compact construction
- Maintenance-free, resulting in minimal time needed for inspection and maintenance
- Integrated preload indicator

- Designed for service temperatures from -40 °C to +80 °C, belt speeds up to 4.0 m/s and belt widths from 400 to 1800 mm
- Suited for use with mechanical joints

Area of application

- Particularly suited for scraper bars made from carbide, rubber or polyurethane with square support tubes such as REMACLEAN KWA/PUR/C/M and particularly HML

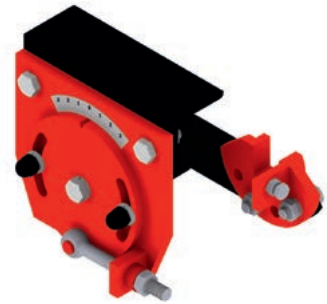

REMACLEAN INNOVATION

REMACLEAN INNOVATION

Ref. No.	Designation	For belt width	Content
578 8320	REMACLEAN INNOVATION	400 - 800 mm	1 pair
578 8330	REMACLEAN INNOVATION	1000 mm	1 pair
578 8360	REMACLEAN INNOVATION	1200 - 1800 mm	1 pair

Reversing stop HM-U3 / HM-U5 / INNOVATION

For REMACLEAN HM-U3/HM-U5/INNOVATION.

Ref. No.	Designation	For belt width	Content
578 8130	Reversing stop	up to 800 mm	1 pair
578 8140	Reversing stop	1000 mm	1 pair
578 8150	Reversing stop	up to 1200 mm	1 pair

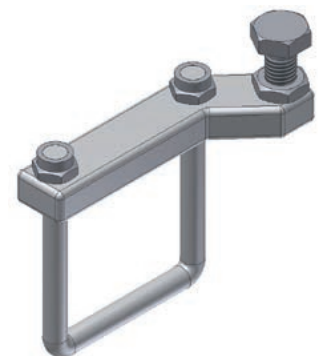

* Provided the condition of a explicit authorization of the plant operator

BELT CLEANING SYSTEMS

REMACLEAN – Tension Unit

REMACLEAN INNOVATION S

Tension unit for universal use with torsion element and one-sided tension unit for optimum inspection and servicing of the system. The contact pressure can be continuously adjusted* using a gear and snapper mechanism. Extremely long service life. Vibration absorbing and flexible due to integrated rubber spring elements. Can be retrofitted with reversing stop that can also be used as a buffer for the support arm.

Properties

- Long-lasting
- Easy fitting – can also retroactively be fitted to all conveyor belt systems with minimal effort
- Tensioning unit can be used on either the left or right side
- Quick and easy scraper bar exchange
- Consistent cleaning performance through consistent contact pressure
- Easy preloading from just one side
- Low design height, compact construction

- Maintenance-free, resulting in minimal time needed for inspection and maintenance
- Designed for service temperatures from –40 °C to +80 °C, belt speeds up to 4.0 m/s and belt widths from 650 to 1200 mm
- Suited for use with mechanical joints

Area of application

- Particularly suited for scraper bars made from carbide, rubber or polyurethane with square support tubes such as REMACLEAN KWA/PUR/C/M/HML



REMACLEAN INNOVATION S

REMACLEAN INNOVATION S

Ref. No.	Designation	Belt width
578 8650	REMACLEAN INNOVATION S	650 mm
578 8660	REMACLEAN INNOVATION S	800 mm
578 8670	REMACLEAN INNOVATION S	1000 mm
578 8680	REMACLEAN INNOVATION S	1200 mm

Spare and wear parts – REMACLEAN INNOVATION S

Ref. No.	Designation
578 8690	Tension unit, for REMACLEAN INNOVATION S



578 8690

* Provided the condition of a explicit authorization of the plant operator

BELT CLEANING SYSTEMS

REMACLEAN – F-Series – for use on pulley

REMACLEAN HM-F1

Belt scraper system with individual elastically supported tungsten carbide blades and a spindle-type tension unit for cleaning of conveyor belt top covers at the head pulley. The solid design of the support tube, where the tungsten carbide segments are elastically mounted, allow the system to be used for belt speeds of up to 6.5 m/s. The tungsten carbide blades optimally adjust to the belt surface and guarantee effective and belt-friendly cleaning as well as long service life and high reliability.

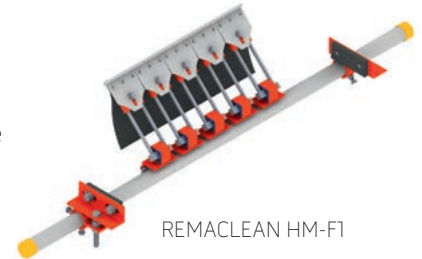

REMACLEAN HM-F1

Properties

- High cleaning efficiency through ideal adaptation of the carbide blades (flexibly and individually mounted) to the belt surface
- Long service life through the use of highly wear-resistant carbide and low-friction, non-stick skirting
- Easy fitment of the scraper beneath the pulley axis (outside of the material's main flow)
- Consistent contact pressure through low-maintenance and high-quality rubber torsion elements
- Open construction of the carbide carriers and the torsion elements for unhampered dispersion of material
- The tensioning device can be shifted inside or outside of the conveyor belt construction

- Also suited for reverse operation
- Designed for service temperatures from $-40\text{ }^{\circ}\text{C}$ to $+80\text{ }^{\circ}\text{C}$, belt speeds up to 6.5 m/s, belt widths to 2400 mm and pulley diameters up to 2000 mm
- Not suited for use with mechanical joints

Area of application

- Universally applicable as a pre-cleaner or main cleaner for many types of materials such as sand, gravel, hard coal, lignite, ores, sinter, cement and in the chemical industry



REMACLEAN HM-F1

Ref. No.	Designation	Belt width	Ref. No.	Designation	Belt width
578 2158	REMACLEAN HM-F1	650 mm	578 2213	REMACLEAN HM-F1	1600 mm
578 2165	REMACLEAN HM-F1	800 mm	578 2220	REMACLEAN HM-F1	1800 mm
578 2189	REMACLEAN HM-F1	1000 mm	578 2237	REMACLEAN HM-F1	2000 mm
578 2196	REMACLEAN HM-F1	1200 mm	578 2244	REMACLEAN HM-F1	2200 mm
578 2206	REMACLEAN HM-F1	1400 mm	578 2251	REMACLEAN HM-F1	2400 mm

Spare and wear parts – REMACLEAN HM-F1

Ref. No.	Designation
578 3803	Hard metal scraper segment HMT-F1, with PE deflector apron, center
578 1080	Hard metal scraper segment HMT-F1, with PE deflector apron, right
578 1070	Hard metal scraper segment HMT-F1, with PE deflector apron, left



BELT CLEANING SYSTEMS

REMACLEAN – F-Series – for use on pulley

REMACLEAN HM-F2

Belt scraper system with individual elastically supported tungsten carbide blades and a spindle-type tension unit for cleaning of conveyor belt top covers at the head pulley. The individual elastically supported tungsten carbide blades can pivot about the axis of the joint. Therefore, the tungsten carbide blades optimally adjust to the belt surface and guarantee effective and belt-friendly cleaning. The scraper blade is tensioned by a spindle type tension unit. The outer tungsten carbide segments are equipped with an indicator showing the contact pressure of the blades.



REMACLEAN HM-F2

Properties

- High cleaning efficiency through ideal adaptation of the carbide blades (flexibly and individually mounted) to the belt surface
- Long service life through the use of highly wear-resistant carbide and low-friction, non-stick skirting
- Easy fitment of the scraper beneath the pulley axis (outside of the material's main flow)
- Open construction of the carbide carriers and the torsion elements for unhampered dispersion of material
- Easily fitted and adjusted; low-maintenance through rubber torsion elements
- Consistent and ideal contact pressure; easily adjustable and definable
- Consistent contact pressure through low-maintenance and high-quality rubber torsion elements
- The tensioning device can be shifted inside or outside of the conveyor belt construction
- Also suited for reverse operation
- Not suited for use with mechanical joints
- Designed for service temperatures from -40 °C to $+80\text{ °C}$, belt speeds up to 4.5 m/s and belt widths to 2000 mm
- A special version in stainless steel and heat-resistant up to $+120\text{ °C}$ is also available

Area of application

- Universally applicable as a pre-cleaner or main cleaner for many types of materials such as sand, gravel, hard coal, lignite, ores, sinter, cement and in the chemical industry

REMACLEAN HM-F2

Ref. No.	Designation	Belt width
578 3009	REMACLEAN HM-F2	400 mm
578 3016	REMACLEAN HM-F2	500 mm
578 3023	REMACLEAN HM-F2	650 mm
578 3030	REMACLEAN HM-F2	800 mm
578 3054	REMACLEAN HM-F2	1000 mm
578 1001	REMACLEAN HM-F2	1200 mm
578 1018	REMACLEAN HM-F2	1400 mm
578 1025	REMACLEAN HM-F2	1600 mm
578 1032	REMACLEAN HM-F2	1800 mm
578 1049	REMACLEAN HM-F2	2000 mm

BELT CLEANING SYSTEMS
 REMACLEAN – F-Series – for use on pulley

REMACLEAN HM-F2 HR

Special model for use at temperatures up to 120 °C.

Ref. No.	Designation	Belt width
578 1221	REMACLEAN HM-F2 HR	500 mm
578 1238	REMACLEAN HM-F2 HR	650 mm
578 1245	REMACLEAN HM-F2 HR	800 mm
578 1269	REMACLEAN HM-F2 HR	1000 mm
578 1276	REMACLEAN HM-F2 HR	1200 mm
578 1283	REMACLEAN HM-F2 HR	1400 mm



REMACLEAN HM-F2 HR

Spare and wear parts – REMACLEAN HM-F2 / HM-F2 HR

Ref. No.	Designation	Width
578 3250	Hard metal scraper segment HMT-F2/120, center	120 mm
578 3267	Hard metal scraper segment HMT-F2/120, right	120 mm
578 3274	Hard metal scraper segment HMT-F2/120, left	120 mm
578 0435	Hard metal scraper segment HMT-F2/240, center	240 mm
578 0442	Hard metal scraper segment HMT-F2/240, right	240 mm
578 0459	Hard metal scraper segment HMT-F2/240, left	240 mm
578 3243	Torsion element HM-F2	
578 3951	Torsion element HM-F2 HR, up to 120 °C	



BELT CLEANING SYSTEMS

REMACLEAN – F-Series – for use on pulley

REMACLEAN HM-F2 VA

Stainless steel model for corrosive media and the food industry. Material 1.4571 (VA).

Ref. No.	Designation	Belt width
578 0167	REMACLEAN HM-F2 VA	400 mm
578 0174	REMACLEAN HM-F2 VA	500 mm
578 0181	REMACLEAN HM-F2 VA	650 mm
578 0198	REMACLEAN HM-F2 VA	800 mm
578 0215	REMACLEAN HM-F2 VA	1000 mm
578 0497	REMACLEAN HM-F2 VA	1200 mm
578 0507	REMACLEAN HM-F2 VA	1400 mm
578 0514	REMACLEAN HM-F2 VA	1600 mm



REMACLEAN HM-F2 VA

Spare and wear parts – REMACLEAN HM-F2 VA

Material 1.4571 (VA).

Ref. No.	Designation	Width
578 0222	Hard metal scraper segment HMT-F2 VA, center	120 mm
578 0239	Hard metal scraper segment HMT-F2 VA, right	120 mm
578 0246	Hard metal scraper segment HMT-F2 VA, left	120 mm
578 0253	Torsion element HM-F2 VA	



BELT CLEANING SYSTEMS

REMACLEAN – F-Series – for use on pulley

REMACLEAN PUR-F3

Primary belt scraper system with a polyurethane blade and a spring lever tension unit for the cleaning of conveyor belt top covers at the head pulley. The polyurethane blade is attached to the system support structure but can revolve around its own axis, if necessary. The scraper blade optimally adjusts to the belt surface and guarantees effective and belt-friendly cleaning. Precise contact pressure is achieved by a spring lever tension unit.

Properties

- Highly effective cleaning through perfect adaptation of the polyurethane bar to the belt's surface
 - Long service life through the use of highly wear-resistant polyurethane
 - Suitable for use with mechanical joints
 - Easily fitted and adjusted; low-maintenance due to the use of the tension springs
 - Also suited for reverse operation and for use with spherical pulleys
 - A version for underground use is also available (ATEX-suitable) as well as a special version in stainless steel
- For belt widths up to 2200 mm and pulley diameters from 220 up to 500 mm
 - Designed for service temperatures from -40 °C to +70 °C and belt speeds up to 4.0 m/s

Area of application

- Universally applicable as a pre-cleaner or main cleaner for many types of materials such as sand, gravel, hard coal, lignite, ores, sinter, cement and in the chemical industry

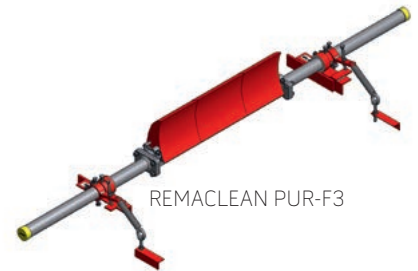

REMACLEAN PUR-F3

REMACLEAN PUR-F3

Ref. No.	Designation	Belt width
578 5504	REMACLEAN PUR-F3	500 mm
578 5505	REMACLEAN PUR-F3	650 mm
578 5506	REMACLEAN PUR-F3	800 mm
578 5507	REMACLEAN PUR-F3	1000 mm
578 5508	REMACLEAN PUR-F3	1200 mm
578 5509	REMACLEAN PUR-F3	1400 mm
578 5510	REMACLEAN PUR-F3	1600 mm
578 5511	REMACLEAN PUR-F3	1800 mm
578 5512	REMACLEAN PUR-F3	2000 mm
578 5513	REMACLEAN PUR-F3	2200 mm

BELT CLEANING SYSTEMS
 REMACLEAN – F-Series – for use on pulley

Spare and wear parts – REMACLEAN PUR-F3

Ref. No.	Designation	Width	Belt width
578 5500	Segment PUR-F3	100 mm	
578 5501	Segment PUR-F3	200 mm	
578 5502	Segment PUR-F3	300 mm	
578 5503	Segment PUR-F3	400 mm	
578 5581	Segment PUR-F3 V, black, with ATEX approval	300 mm	
578 5591	Segment PUR-F3 V, black, with ATEX approval	400 mm	
578 5696	Belt scraper construction PUR-F3 / PUR-F4 VA		650 mm
578 5690	Belt scraper construction PUR-F3 / PUR-F4 VA		800 mm
578 5691	Belt scraper construction PUR-F3 / PUR-F4 VA		1000 mm
578 5692	Belt scraper construction PUR-F3 / PUR-F4 VA		1200 mm
578 5693	Belt scraper construction PUR-F3 / PUR-F4 VA		1400 mm
578 5694	Belt scraper construction PUR-F3 / PUR-F4 VA		1600 mm
578 5695	Belt scraper construction PUR-F3 / PUR-F4 VA		1800 mm
578 5270	Belt scraper construction PUR-F3 / PUR-F4 VA		2000 mm
578 4930	Supporting tube PUR-F3 / PUR-F4		800 mm
578 4940	Supporting tube PUR-F3 / PUR-F4		1000 mm
578 4950	Supporting tube PUR-F3 / PUR-F4		1200 mm
578 4960	Supporting tube PUR-F3 / PUR-F4		1400 mm
578 4970	Supporting tube PUR-F3 / PUR-F4		1600 mm
578 4980	Supporting tube PUR-F3 / PUR-F4		1800 mm
578 4981	Supporting tube PUR-F3 / PUR-F4		2000 mm
578 4982	Supporting tube PUR-F3 / PUR-F4		2200 mm
578 4990	Lengthning piece – supporting tube PUR-F3 / PUR-F4 / PUR-F5, light		
578 4991	Lengthning piece reinforced – supporting tube PUR-F3 / PUR-F4 / PUR-F5, heavy		

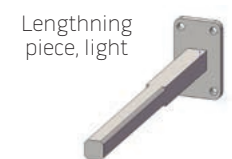

BELT CLEANING SYSTEMS

REMACLEAN – F-Series – for use on pulley

REMACLEAN PUR-F4

Primary belt scraper system with a polyurethane blade and a spring lever tension unit for the cleaning of conveyor belt top covers at the head pulley. The polyurethane blade is attached to the system support structure yet can revolve around its own axis, if necessary. The scraper blade optimally adjusts to the belt surface and guarantees effective and belt-friendly cleaning. Precise contact pressure is achieved by a spring lever tension unit.

Properties

- Highly effective cleaning through perfect adaptation of the polyurethane bar to the belt's surface
- Long service life through the use of highly wear-resistant polyurethane
- Suitable for use with mechanical joints
- Easily fitted and adjusted, low-maintenance due to the use of the tension springs
- Also suited for reverse operation and for use with spherical pulleys
- A version for underground use is also available (ATEX-suitable) as well as a special version in stainless steel
- For belt widths up to 2200 mm and pulley diameters from 500 up to 1600 mm
- Designed for service temperatures from -40 °C to +70 °C and belt speeds up to 4.0 m/s

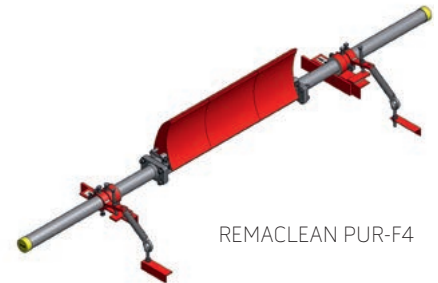

REMACLEAN PUR-F4

Area of application

- Universally applicable as a pre-cleaner or main cleaner for many types of materials such as sand, gravel, hard coal, lignite, ores, sinter, cement and in the chemical industry

REMACLEAN PUR-F4

Ref. No.	Designation	Belt width
578 5524	REMACLEAN PUR-F4	500 mm
578 5525	REMACLEAN PUR-F4	650 mm
578 5526	REMACLEAN PUR-F4	800 mm
578 5527	REMACLEAN PUR-F4	1000 mm
578 5528	REMACLEAN PUR-F4	1200 mm
578 5529	REMACLEAN PUR-F4	1400 mm
578 5530	REMACLEAN PUR-F4	1600 mm
578 5531	REMACLEAN PUR-F4	1800 mm
578 5532	REMACLEAN PUR-F4	2000 mm
578 5533	REMACLEAN PUR-F4	2200 mm
578 5800	REMACLEAN PUR-F4 V, with ATEX approval	800 mm
578 5810	REMACLEAN PUR-F4 V, with ATEX approval	1000 mm
578 5820	REMACLEAN PUR-F4 V, with ATEX approval	1200 mm
578 5830	REMACLEAN PUR-F4 V, with ATEX approval	1400 mm

BELT CLEANING SYSTEMS
 REMACLEAN – F-Series – for use on pulley

Spare and wear parts – REMACLEAN PUR-F4

Ref. No.	Designation	Width	Belt width
578 5520	Segment PUR-F4	100 mm	
578 5521	Segment PUR-F4	200 mm	
578 5522	Segment PUR-F4	300 mm	
578 5523	Segment PUR-F4	400 mm	
578 5580	Segment PUR-F4 V	300 mm	
578 5590	Segment PUR-F4 V	400 mm	
578 5696	Belt scraper construction PUR-F3 / PUR-F4 VA		650 mm
578 5690	Belt scraper construction PUR-F3 / PUR-F4 VA		800 mm
578 5691	Belt scraper construction PUR-F3 / PUR-F4 VA		1000 mm
578 5692	Belt scraper construction PUR-F3 / PUR-F4 VA		1200 mm
578 5693	Belt scraper construction PUR-F3 / PUR-F4 VA		1400 mm
578 5694	Belt scraper construction PUR-F3 / PUR-F4 VA		1600 mm
578 5695	Belt scraper construction PUR-F3 / PUR-F4 VA		1800 mm
578 5270	Belt scraper construction PUR-F3 / PUR-F4 VA		2000 mm
578 4930	Supporting tube PUR-F3 / PUR-F4		800 mm
578 4940	Supporting tube PUR-F3 / PUR-F4		1000 mm
578 4950	Supporting tube PUR-F3 / PUR-F4		1200 mm
578 4960	Supporting tube PUR-F3 / PUR-F4		1400 mm
578 4970	Supporting tube PUR-F3 / PUR-F4		1600 mm
578 4980	Supporting tube PUR-F3 / PUR-F4		1800 mm
578 4981	Supporting tube PUR-F3 / PUR-F4		2000 mm
578 4982	Supporting tube PUR-F3 / PUR-F4		2200 mm
578 4990	Lengthning piece – supporting tube PUR-F3 / PUR-F4, light		
578 4991	Lengthning piece reinforced – supporting tube PUR-F3 / PUR-F4, heavy		



578 5520



578 5521



578 5522



578 5523



Belt scraper construction

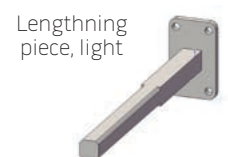

Lengthning piece, light



Lengthning piece, heavy

BELT CLEANING SYSTEMS

REMACLEAN – F-Series – for use on pulley

REMACLEAN PUR-F4 A

Primary belt scraper system with a polyurethane blade and a spring lever tension unit for the cleaning of conveyor belt top covers at the head pulley. The polyurethane blade is attached to the system support structure yet can revolve around its own axis, if necessary. The scraper blade optimally adjusts to the belt surface and guarantees effective and belt-friendly cleaning. Precise contact pressure is achieved by a spring lever tension unit.

Properties

- Highly effective cleaning through perfect adaptation of the polyurethane bar to the belt's surface
 - Long service life through the use of highly wear-resistant polyurethane
 - Suitable for use with mechanical joints
 - Easily fitted and adjusted, low-maintenance due to the use of the tension springs
 - Also suited for reverse operation and for use with spherical pulleys
 - A version for underground use is also available (ATEX-suitable) as well as a special version in stainless steel
- For belt widths up to 2000 mm and pulley diameters from 500 up to 1600 mm
 - Designed for service temperatures from -40 °C to +70 °C and belt speeds up to 4.0 m/s

Area of application

- Universally applicable as a pre-cleaner or main cleaner for many types of materials such as sand, gravel, hard coal, lignite, ores, sinter, cement and in the chemical industry

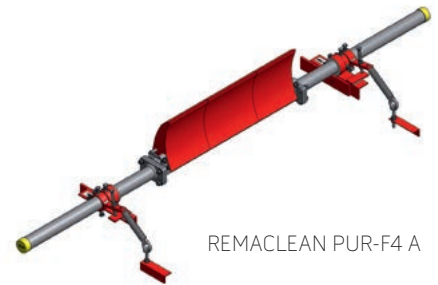

REMACLEAN PUR-F4 A

REMACLEAN PUR-F4 A

Ref. No.	Designation	Belt width
578 5700	REMACLEAN PUR-F4 A	500 mm
578 5710	REMACLEAN PUR-F4 A	650 mm
578 5720	REMACLEAN PUR-F4 A	800 mm
578 5730	REMACLEAN PUR-F4 A	1000 mm
578 5740	REMACLEAN PUR-F4 A	1200 mm
578 5750	REMACLEAN PUR-F4 A	1400 mm
578 5760	REMACLEAN PUR-F4 A	1600 mm
578 5770	REMACLEAN PUR-F4 A	1800 mm
578 5780	REMACLEAN PUR-F4 A	2000 mm

BELT CLEANING SYSTEMS

REMACLEAN – F-Series – for use on pulley

REMACLEAN PUR-F5

Conveyor belt cleaning system with a scraper consisting of polyurethane segments and a lever tensioning system with a compression spring for cleaning the conveyor belt load-bearing side at the head pulley. The individual polyurethane segments are permanently attached to the support. Due to a special function, the segments can always move elastically. This allows the segments to contact the conveyor belt surface at the drum optimally and ensures effective and gentle cleaning. The entire scraper strip is exactly pretensioned at one or both sides by means of the lever tensioning unit.

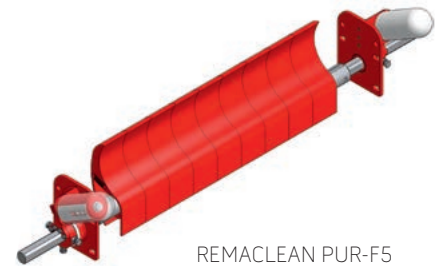

REMACLEAN PUR-F5

Properties

- High cleaning efficiency through perfect adaptation of the polyurethane segments to the belt's surface
- Long service life through the use of highly wear-resistant polyurethane
- Easily fitted and adjusted; low-maintenance
- Each segment is mounted to the system carrier with a quick-tensioning fastener
- Consistent and ideal contact pressure; easily adjustable and, through the length of the cylinder spring, easily definable; a pre-tension indicator is provided
- Up to a belt width of 1400 mm pre-tensioning occurs from only one side
- PUR-segments are also available in a natural white colour
- Stainless steel system carrier available
- Segment width of 100 mm
- For belt widths up to 1400 mm and pulley diameters from 240 up to 800 mm
- Designed for the highest loads with service temperatures from $-40\text{ }^{\circ}\text{C}$ to $+60\text{ }^{\circ}\text{C}$ and belt speeds up to 4.0 m/s

Area of application

- Universally applicable as a pre-cleaner or main cleaner for many types of materials such as sand, gravel, hard coal, lignite, ores, sinter, cement and in the chemical industry

REMACLEAN PUR-F5

Ref. No.	Designation	Belt width	Ref. No.	Designation	Belt width
578 5600	REMACLEAN PUR-F5	500 mm	578 5630	REMACLEAN PUR-F5	1000 mm
578 5610	REMACLEAN PUR-F5	650 mm	578 5640	REMACLEAN PUR-F5	1200 mm
578 5620	REMACLEAN PUR-F5	800 mm	578 5650	REMACLEAN PUR-F5	1400 mm



578 5660

Spare and wear parts – REMACLEAN PUR-F5

Ref. No.	Designation	Width
578 5660	Segment PUR-F5	100 mm
578 5670	Mounting plate PUR-F5, with bearing	
578 5680	Mounting plate PUR-F5, with bearing and tensioning device	



578 5680

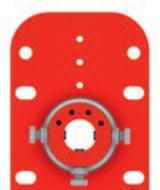

578 5670

BELT CLEANING SYSTEMS

REMACLEAN – F-Series – for use on pulley in large conveyor systems

REMACLEAN PUR-F300

REMACLEAN PUR-F300 is intended for pre-cleaning at the discharge pulley for pulley diameters from 630 mm and up. The individual polyurethane segments are solidly connected to the carrier. Due to a special function, the segments are more flexible. Thus the segments adapt themselves perfectly to the belt's surface at the pulley and ensure effective and gentle cleaning. Through the contact pressure device the entire scraper bar with the PUR-segments is precisely pre-tensioned from either one, or both sides.



REMACLEAN PUR-F300

Properties

- High cleaning efficiency through perfect adaptation of the polyurethane segments (individually mounted) to the belt's surface
- Long service life through the use of highly wear-resistant polyurethane
- Each segment is equipped with a supporting spring and can thus function in a dynamic manner; height differences are compensated for
- Segment widths of 200 mm and 300 mm
- Easily fitted and adjusted; low-maintenance
- Consistent and ideal contact pressure; easily adjustable and, through the length of the cylinder springs, easily definable
- The segment carrier has a very strong design for the highest loads (box profile)
- Also suitable for reverse operation
- Run-off aprons at the back of the PUR-segments protect the carrier body
- Designed for pulley diameters from 630 mm and belt speeds up to 6.5 m/s

Area of application

- Suitable for large conveyor systems
- Universally applicable to many types of materials such as sand, gravel, hard coal, lignite, ores, sinter and cement

REMACLEAN PUR-F300

Ref. No.	Designation	Belt width
578 5843	REMACLEAN PUR-F300	900 mm
578 5842	REMACLEAN PUR-F300	1000 mm
578 5841	REMACLEAN PUR-F300	1200 mm
578 5840	REMACLEAN PUR-F300	1400 mm
578 5291	REMACLEAN PUR-F300	1600 mm
578 5290	REMACLEAN PUR-F300	1800 mm
578 5280	REMACLEAN PUR-F300	2000 mm

Spare and wear parts – REMACLEAN PUR-F300

Ref. No.	Designation	Width
578 5850	Segment PUR-F300	200 mm
578 5860	Segment PUR-F300	300 mm

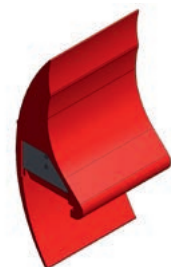

BELT CLEANING SYSTEMS

REMACLEAN – F-Series – for use on pulley in large conveyor systems

REMACLEAN PUR-F400

REMACLEAN PUR-F400 is intended for pre-cleaning at the discharge pulley for pulley diameters from 1000 mm and up. The individual polyurethane segments are solidly connected to the carrier. Due to a special function, the segments are more flexible. Thus the segments adapt themselves perfectly to the belt's surface at the pulley and ensure effective and gentle cleaning. Through the contact pressure device the entire scraper bar with the PUR segments is precisely pre-tensioned from either one, or both sides.



REMACLEAN PUR-F400

Properties

- High cleaning efficiency through perfect adaptation of the polyurethane segments (individually mounted) to the belt's surface
- Long service life through the use of highly wear-resistant polyurethane
- Each segment is equipped with a supporting spring and can thus function in a dynamic manner; height differences are compensated for

- Segment widths of 200 mm and 300 mm
- Easily fitted and adjusted; low-maintenance
- Consistent and ideal contact pressure; easily adjustable and, through the length of the cylinder springs, easily definable
- The segment carrier has a very strong design for the highest loads (box profile)
- Also suitable for reverse operation

- Run-off aprons at the back of the PUR-segments protect the carrier body
- Designed for pulley diameters from 1000 mm and belt speeds up to 6.5 m/s

Area of application

- Suitable for large conveyor systems
- Universally applicable to many types of materials such as sand, gravel, hard coal, lignite, ores, sinter and cement

REMACLEAN PUR-F400

Ref. No.	Designation	Belt width
578 6080	REMACLEAN PUR-F400	1600 mm
578 6081	REMACLEAN PUR-F400	1800 mm
578 6110	REMACLEAN PUR-F400	2000 mm
578 6120	REMACLEAN PUR-F400	2200 mm

Spare and wear parts – REMACLEAN PUR-F400

Ref. No.	Designation	Width
578 6090	Segment PUR-F400	200 mm
578 6100	Segment PUR-F400	300 mm

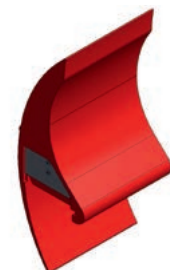

BELT CLEANING SYSTEMS

REMACLEAN – F-Series – for use on pulley in large conveyor systems

REMACLEAN PUR-F500

REMACLEAN PUR-F500 is optimally suited for the cleaning of the carrier-side of belts in large systems with belt speeds of up to 10 m/s. The individual segments of the system are solidly connected to the carrier body, yet mounted in such a way that they have flexible movement. This enables them to adapt perfectly to the belt's surface and ensure effective and gentle cleaning.



REMACLEAN PUR-F500

Properties

- High cleaning efficiency through perfect adaptation of the PUR segments (individually mounted) to the belt's surface
- Long service life of the individual segments through the use of highly wear-resistant polyurethane
- Each segment is equipped with supporting springs, and can thus work in a dynamic manner
- Easy fitment and adjustment; low-maintenance
- Consistent and ideal contact pressure; easily adjustable and, through the length of the cylinder springs, easily definable
- Carrier body has a very strong design in order to cope with the highest loads (box profile)
- Run-off aprons at the back of the PUR segments protect the carrier body

- Designed for belt speeds up to 10 m/s

Area of application

- Suitable for large conveyor systems
- Universally applicable to many types of materials such as sand, gravel, hard coal, lignite and ores

REMACLEAN PUR-F500

Ref. No.	Designation	Belt width	Ref. No.	Designation	Belt width
578 5910	REMACLEAN PUR-F500, 4 segments	1400 mm	578 5570	REMACLEAN PUR-F500, 6 segments	2200 mm
578 5920	REMACLEAN PUR-F500, 4 segments	1400 mm	578 5940	REMACLEAN PUR-F500, 7 segments	2200 mm
578 5571	REMACLEAN PUR-F500, 4 segments	1600 mm	578 5950	REMACLEAN PUR-F500, 7 segments	2400 mm
578 5572	REMACLEAN PUR-F500, 5 segments	1600 mm	578 5960	REMACLEAN PUR-F500, 8 segments	2600 mm
578 5573	REMACLEAN PUR-F500, 5 segments	1600 mm	578 5970	REMACLEAN PUR-F500, 8 segments	2800 mm
578 5930	REMACLEAN PUR-F500, 5 segments	1800 mm	578 5980	REMACLEAN PUR-F500, 9 segments	2800 mm
578 5870	REMACLEAN PUR-F500, 6 segments	2000 mm	578 5990	REMACLEAN PUR-F500, 9 segments	3000 mm

Spare and wear parts – REMACLEAN PUR-F500

Ref. No.	Designation	Width
578 5900	Segment PUR-F500	300 mm



BELT CLEANING SYSTEMS

REMACLEAN – U-Series – for use on belt

REMACLEAN HM-U1

REMACLEAN HM-U1 is a belt cleaning system for belt return side applications consisting of tungsten carbide segments. The solid design of the support tube, where the tungsten carbide segments are mounted, and the spindle-type tension unit allows the system to be used for belt speeds up to 6.5 m/s. The design of the carbide blade perfectly adjusts to the belt, thus providing an effective and belt-friendly cleaning. The design of the carbide blade, as well as its anti-caking coating made of polyethylene, guarantee extended service life and high reliability.

Properties

- Effective cleaning performance
- Long service life through the use of highly wear-resistant carbide
- Modular design consisting of the system suspension tube, carbide-blades (HMT) with PE-deflector plate, suspension tube extensions and spindle sets with torsional thrust bearing
- Consistent and ideal contact pressure; easily adjustable and easily readable on the pre-tension indicator
- Flange connection for easy and quick installation and de-installation
- Spindle sets can be mounted on the inside and outside of the conveyor belt construction
- Protection of the belt edges through sunken outer carbide-carriers (HMT)
- Can be upgraded for reverse operation
- For belt widths up to 2400 mm
- Designed for service temperatures from -40 °C to +80 °C and belt speeds up to 6.5 m/s
- Special versions available for service temperatures up to 120 °C and also made from stainless steel



REMACLEAN HM-U1



Area of application

- Universally applicable for the fine cleaning to many types of materials such as sand, gravel, hard coal, lignite, ores, sinter, cement, clay, refuse and gypsum

REMACLEAN HM-U1

Ref. No.	Designation	Belt width
578 9137	REMACLEAN HM-U1	400 mm
578 9144	REMACLEAN HM-U1	500 mm
578 9151	REMACLEAN HM-U1	650 mm
578 9168	REMACLEAN HM-U1	800 mm
578 9182	REMACLEAN HM-U1	1050 mm
578 9199	REMACLEAN HM-U1	1200 mm
578 9209	REMACLEAN HM-U1	1400 mm
578 9216	REMACLEAN HM-U1	1600 mm
578 9223	REMACLEAN HM-U1	1800 mm
578 9230	REMACLEAN HM-U1	2000 mm
578 9247	REMACLEAN HM-U1	2200 mm
578 9254	REMACLEAN HM-U1	2400 mm

BELT CLEANING SYSTEMS
REMACLEAN – U-Series – for use on belt

Spare and wear parts – REMACLEAN HM-U1

Ref. No.	Designation	Width
578 9326	Hard metal scraper segment HMT-U1, with PE skirting, center	120 mm
578 9333	Hard metal scraper segment HMT-U1, with PE skirting, right	120 mm
578 9340	Hard metal scraper segment HMT-U1, with PE skirting, left	120 mm



Accessories – REMACLEAN HM-U1

Ref. No.	Designation	For belt width	Content
578 9371	Hard metal scraper segment HMT-U1, without PE skirting, 120 mm		50
578 9508	Reversing stop set	400 - 650 mm	
578 9515	Reversing stop set	800 - 1000 mm	
578 9522	Reversing stop set	1200 - 1400 mm	
578 9539	Reversing stop set	from 1600 mm	
578 9845	Step tread set, with fastening elements	400 - 800 mm	2

REMACLEAN HM-U1 HR

Special model for use at temperatures up to 120 °C. Other belt widths on request.

Ref. No.	Designation	Belt width
578 3281	REMACLEAN HM-U1 HR	400 mm
578 3298	REMACLEAN HM-U1 HR	500 mm
578 3308	REMACLEAN HM-U1 HR	650 mm
578 3315	REMACLEAN HM-U1 HR	800 mm
578 3322	REMACLEAN HM-U1 HR	900 mm
578 3339	REMACLEAN HM-U1 HR	1000 mm
578 3340	REMACLEAN HM-U1 HR	1200 mm



REMACLEAN HM-U1 HR

BELT CLEANING SYSTEMS
 REMACLEAN – U-Series – for use on belt

Spare and wear parts – REMACLEAN HM-U1 HR

Ref. No.	Designation	Width
578 9807	Hard metal scraper segment HMT-U1 HR, with VA skirting, center	120 mm
578 9814	Hard metal scraper segment HMT-U1 HR, with VA skirting, right	120 mm
578 9821	Hard metal scraper segment HMT-U1 HR, with VA skirting, left	120 mm



REMACLEAN HM-U1 VA

Special versions for the chemical and food industry. Material 1.4571 (VA).

Ref. No.	Designation	Belt width
578 5210	REMACLEAN HM-U1 VA	500 mm
578 5227	REMACLEAN HM-U1 VA	650 mm
578 5234	REMACLEAN HM-U1 VA	800 mm
578 5258	REMACLEAN HM-U1 VA	1000 mm
578 5260	REMACLEAN HM-U1 VA	1200 mm



REMACLEAN HM-U1 VA

9

Spare and wear parts – REMACLEAN HM-U1 VA

Material 1.4571 (VA).

Ref. No.	Designation
578 9883	Hard metal scraper segment HMT-U1 VA, with VA skirting, center
578 9890	Hard metal scraper segment HMT-U1 VA, with VA skirting, right
578 9900	Hard metal scraper segment HMT-U1 VA, with VA skirting, left



BELT CLEANING SYSTEMS

REMACLEAN – U-Series – for use on belt

REMACLEAN HM-U2

REMACLEAN HM-U2 is a belt scraper system for belt return side applications with a tungsten carbide blade. The solid design of the support tube, where the tungsten carbide blade is mounted, allows the system to be used for belt speeds up to 6.5 m/s. The tungsten carbide blade optimally adjusts to the belt surface and guarantees effective and belt-friendly cleaning. The design of the scraper blade and the anti caking coating made of highly wear-resistant REMATHAN ensure long service life and high reliability.

Properties

- Effective cleaning performance
- Long service life through the use of highly wear-resistant carbide and low-friction anti-caking coatings
- Modular design consisting of the system suspension tube, carbide-blade, suspension tube extension and spindle sets with torsional thrust bearing
- Flange connection for easy and quick fitment
- Easily fitted and adjusted; low-maintenance due to the use of a spindle contact device with torsion elements and a pre-tension indicator
- Spindle sets can be mounted on the inside and outside of the conveyor belt construction
- Consistent and ideal contact pressure, which is easily adjustable and readable on the pre-tension indicator
- The highly wear-resistant REMATHAN sliding units on the front of the carbide-bar ensure accumulation-free removal of the material
- Protection of the belt edges through sunken outer carbide-blade
- Can be upgraded for reverse operation
- Very robust polyurethane skirting
- One-piece blade
- For belt widths up to 2400 mm



REMACLEAN HM-U2

- Designed for service temperatures from $-40\text{ }^{\circ}\text{C}$ to $+80\text{ }^{\circ}\text{C}$ and belt speeds up to 6.5 m/s

Area of application

- Universally applicable for the fine cleaning to many types of materials such as sand, gravel, hard coal, lignite, ores, sinter, cement, clay, refuse and gypsum

REMACLEAN HM-U2

Ref. No.	Designation	Belt width
578 9278	REMACLEAN HM-U2	500 mm
578 9285	REMACLEAN HM-U2	650 mm
578 9292	REMACLEAN HM-U2	800 mm
578 0112	REMACLEAN HM-U2	1000 mm
578 0920	REMACLEAN HM-U2	1200 mm
578 0930	REMACLEAN HM-U2	1400 mm
578 0931	REMACLEAN HM-U2	1600 mm
578 0932	REMACLEAN HM-U2	1800 mm
578 0933	REMACLEAN HM-U2	2000 mm
578 0934	REMACLEAN HM-U2	2200 mm

BELT CLEANING SYSTEMS
 REMACLEAN – U-Series – for use on belt

Spare and wear parts – REMACLEAN HM-U2

Ref. No.	Designation	Belt width
578 9412	Hard metal scraper segment HMT-U2	500 mm
578 9429	Hard metal scraper segment HMT-U2	650 mm
578 9436	Hard metal scraper segment HMT-U2	800 mm
578 0136	Hard metal scraper segment HMT-U2	1000 mm
578 0140	Hard metal scraper segment HMT-U2	1200 mm
578 0150	Hard metal scraper segment HMT-U2	1400 mm
578 0950	Hard metal scraper segment HMT-U2	1600 mm
578 0951	Hard metal scraper segment HMT-U2	1800 mm
578 0952	Hard metal scraper segment HMT-U2	2000 mm
578 0953	Hard metal scraper segment HMT-U2	2200 mm



Accessories – REMACLEAN HM-U2

Ref. No.	Designation	For belt width	Content
578 9508	Reversing stop set	400 - 650 mm	
578 9515	Reversing stop set	800 - 1000 mm	
578 9522	Reversing stop set	1200 - 1400 mm	
578 9845	Step tread set, with fastening elements	400 - 800 mm	2

BELT CLEANING SYSTEMS

REMACLEAN – U-Series – for use on belt

REMACLEAN HM-U3

REMACLEAN HM-U3 is a belt scraper system for belt return side applications with a tungsten carbide blade featuring a low installation height and tension unit type INNOVATION. The tungsten carbide blade optimally adjusts to the belt and therefore guarantees effective and belt-friendly cleaning. The design of the tungsten carbide blade as well as the multi layer anti-caking coating guarantees long service life and high reliability. The tension unit type INNOVATION allows continuous calibration of the contact pressure and fits various installation situations.

Properties

- Effective cleaning performance
- Long service life through the use of highly wear-resistant carbide
- Protection of the belt surface edges through sunken outer carbide-blade
- Easy fitting and adjustment of the system due to the use of the tension unit INNOVATION with torsion elements and a pre-tension indicator
- Spindle sets can be mounted on the inside and outside of the conveyor belt construction
- Low-maintenance
- Requires little space due to the compact carbide-blade
- Automatic system readjustment
- Tension unit INNOVATION with accurate micro-adjustment of the contact pressure

- Integrated scraper bar tilt-adjustment
- REMA-REPCOAT SL non-stick coating on the carbide-bar's off-flow side
- Can be upgraded for reverse operation
- For belt widths up to 1200 mm
- Designed for service temperatures from $-40\text{ }^{\circ}\text{C}$ to $+80\text{ }^{\circ}\text{C}$ and belt speeds up to 4.0 m/s
- Special versions available for service temperatures up to $130\text{ }^{\circ}\text{C}$ and also with electro-galvanized bar

Area of application

- Universally applicable to many types of materials such as sand, gravel, hard coal, lignite, ores, sinter, cement, clay, refuse and gypsum

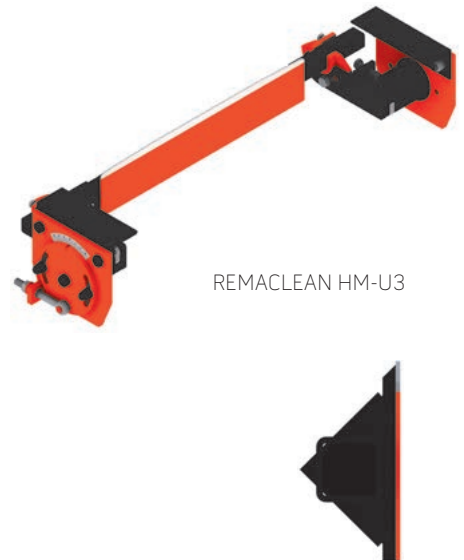

REMACLEAN HM-U3

REMACLEAN HM-U3

Ref. No.	Designation	Belt width
578 8900	REMACLEAN HM-U3	400 mm
578 8910	REMACLEAN HM-U3	500 mm
578 8920	REMACLEAN HM-U3	650 mm
578 8930	REMACLEAN HM-U3	800 mm
578 8940	REMACLEAN HM-U3	1000 mm
578 8950	REMACLEAN HM-U3	1200 mm

BELT CLEANING SYSTEMS

REMACLEAN – U-Series – for use on belt

REMACLEAN HM-U4

Belt cleaning system for belt return side applications with a "CONTOUR" tungsten carbide blade and tension unit type STANDARD. The parabolic design of the tungsten carbide blade optimally adjusts to the conveyor belt – even in case of progressive wear in the center of the belt – and therefore guarantees effective and belt-friendly cleaning.

Properties

- Effective cleaning due to the scraper bar's parabolic form
 - Adapts well to the belt's surface
 - Long service life through the use of highly wear-resistant carbide made in shock-resistant design
 - Requires little space for fitment
 - Easy fitment and adjustment of the scraper system
 - Low-maintenance
 - Automatic system readjustment through rubber suspension elements
 - Integrated tilt-adjustment for optimal positioning
- Scraper bar is coated with a high-quality anti-corrosion layer
 - Not suitable for reverse operation
 - Protection of the belt edges through sunken outer carbide-blades
 - For belt widths up to 1200 mm
 - Designed for service temperatures from -40 °C to +80 °C and belt speeds up to 2.5 m/s

Area of application

- Universally applicable to many types of materials such as moist sand and gravel, hard coal, cement, refuse and recycle materials



REMACLEAN HM-U4

REMACLEAN HM-U4

Ref. No.	Designation	Belt width
578 9260	REMACLEAN HM-U4, with parabolic bar	500 mm
578 9261	REMACLEAN HM-U4, with parabolic bar	650 mm
578 9262	REMACLEAN HM-U4, with parabolic bar	800 mm
578 9263	REMACLEAN HM-U4, with parabolic bar	1000 mm
578 9264	REMACLEAN HM-U4, with parabolic bar	1200 mm
578 5550	Tension unit SE 27 HM-U4	to 800 mm
578 5560	Tension unit SE 38 HM-U4	from 1000 mm

BELT CLEANING SYSTEMS

REMACLEAN – U-Series – for use on belt

REMACLEAN HM-U5

Belt cleaning system for belt return side applications with a "CONTOUR" tungsten carbide blade and tension unit type INNOVATION, that allows continuous calibration of the contact pressure and fits various installation situations. The parabolic design of the tungsten carbide blade optimally adjusts to the conveyor belt – even in case of progressive wear in the center of the belt – and therefore guarantees effective and belt-friendly cleaning.

Properties

- Effective cleaning through the scraper bar's parabolic form
 - Adapts well to the belt's surface
 - Long service life through the use of highly wear-resistant carbide made in shock-resistant design
 - Requires little space for fitment
 - Easy fitment and adjustment of the scraper system
 - Low-maintenance
 - Integrated tilt-adjustment for optimal positioning
 - Scraper bar is coated with a high-quality anti-corrosion layer
- Not suitable for reverse operation
 - Protection of the belt edges through sunken outer carbide-blades
 - For belt widths up to 1200 mm
 - Designed for service temperatures from -40 °C to +80 °C and belt speeds up to 2.5 m/s

Area of application

- Universally applicable to many types of materials such as moist sand and gravel, hard coal, cement, refuse and recycle materials

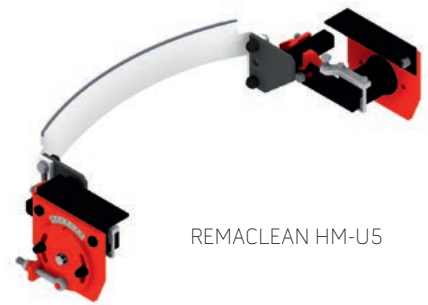

REMACLEAN HM-U5

Ref. No.	Designation	Belt width
578 9360	REMACLEAN HM-U5, with parabolic bar	500 mm
578 9361	REMACLEAN HM-U5, with parabolic bar	650 mm
578 9362	REMACLEAN HM-U5, with parabolic bar	800 mm
578 9363	REMACLEAN HM-U5, with parabolic bar	1000 mm
578 9364	REMACLEAN HM-U5, with parabolic bar	1200 mm
578 9950	Connection piece HM-U5	up to 800 mm
578 9960	Connection piece HM-U5	from 1000 mm

BELT CLEANING SYSTEMS
 REMACLEAN – U-Series – for use on belt

Spare and wear parts – REMACLEAN HM-U3 / HM-U4 / HM-U5

Reversing stop HM-U3 / HM-U5 / INNOVATION

Ref. No.	Designation	For belt width	Content
578 8130	Reversing stop	up to 800 mm	1 pair
578 8140	Reversing stop	1000 mm	1 pair
578 8150	Reversing stop	up to 1200 mm	1 pair



Reversing stop

Spare and wear parts – REMACLEAN HM-U3

Ref. No.	Designation	Belt width
578 2010	REMACLEAN HML	400 mm
578 2020	REMACLEAN HML	500 mm
578 2030	REMACLEAN HML	650 mm
578 2040	REMACLEAN HML	800 mm
578 2060	REMACLEAN HML	1000 mm
578 2070	REMACLEAN HML	1200 mm



9

Spare and wear parts – REMACLEAN HM-U4 / HM-U5

Ref. No.	Designation	Belt width
578 9400	HMT-CONTOUR	500 mm
578 9401	HMT-CONTOUR	650 mm
578 9402	HMT-CONTOUR	800 mm
578 9403	HMT-CONTOUR	1000 mm
578 9404	HMT-CONTOUR	1200 mm

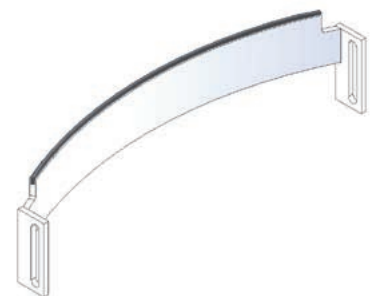

BELT CLEANING SYSTEMS

REMACLEAN – U-Series – for use on belt

REMACLEAN HM-U6

Belt cleaning system for return side application with elastically mounted carbide segments and a torsion tension unit with spindle adjustment. The individual elastically supported carbide segments achieve optimum cleaning efficiency while avoiding damage to the conveyor belt surface. The segments dynamically adjust to the belt surface and hence ensure effective and belt-friendly cleaning. Plastic skirts prevent that material builds up on the elements.

Properties

- Belt-friendly cleaning achieved by the sagging function of the blade segments
- The tungsten carbide segments are individually supported and can adapt dynamically in the running direction of the belt
- Modular system composed of system suspension tube, carbide-blades, polyurethane deflector
- Spindle sets with torsional thrust bearing included
- Consistent and ideal contact pressure, which is easily adjustable by using the torsion tension unit with spindle adjustment
- Particularly robust polyurethane sliding deflectors for highest demands
- Not suitable for reverse operation
- For belt widths up to 2000 mm
- Designed for service temperatures from -40 °C to $+70\text{ °C}$ and belt speeds up to 2.5 m/s

Area of application

- Universally applicable to many types of materials such as sand, gravel, hard coal, lignite, ores, sinter, cement, clay, conditioned refuse and gypsum

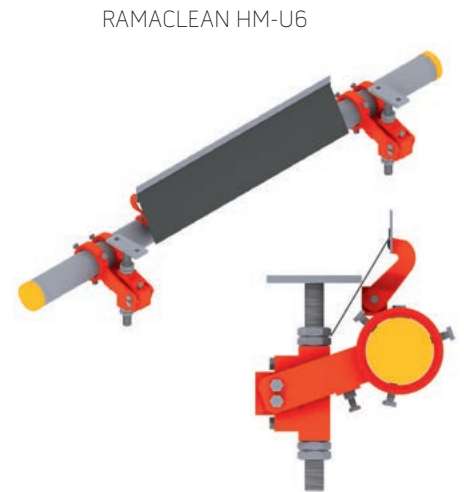

REMACLEAN HM-U6

Ref. No.	Designation	Belt width
578 8960	REMACLEAN HM-U6	400 mm
578 8961	REMACLEAN HM-U6	500 mm
578 8962	REMACLEAN HM-U6	650 mm
578 8963	REMACLEAN HM-U6	800 mm
578 8964	REMACLEAN HM-U6	1000 mm
578 8965	REMACLEAN HM-U6	1200 mm
578 8966	REMACLEAN HM-U6	1400 mm
578 8967	REMACLEAN HM-U6	1600 mm
578 8968	REMACLEAN HM-U6	1800 mm
578 8969	REMACLEAN HM-U6	2000 mm

Spare and wear parts – REMACLEAN HM-U6

Ref. No.	Designation
578 8590	Hard metal scraper HMT-U6, with polyurethane skirt

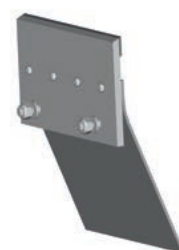

578 8590

BELT CLEANING SYSTEMS

REMACLEAN – U-Series – for use on belt

REMACLEAN HM-U7

REMACLEAN HM-U7

Belt cleaning system for belt return side applications with elastically supported tungsten carbide blades and a spindle-type tension unit. High cleaning efficiency and long service life due to the high-quality of the carbides. Good adaptability to the conveyor belt through flexibly mounted and overlapping of the blades. Belt-protective scraper system through the segment blades dragging function.

Properties

- Belt-friendly cleaning achieved by the sagging function of the blade segments
- The tungsten carbide segments manufactured from stainless steel are individually supported, can adapt dynamically in the running direction of the belt and move 180° on its own axis
- Modular system composed of system suspension tube, carbide-blades, polyurethane deflector
- Consistent and ideal contact pressure, which is easily adjustable by using the torsion tension unit with spindle adjustment
- No tools needed for segment fitment – exchange due to clamping fastener
- Not suitable for reverse operation
- "MF" version is suitable for the use with mechanical joints
- "V" version is suitable for ATEX applications (in that case assembly feet are black)
- For belt widths up to 1400 mm



- Designed for service temperatures from -40 °C to +70 °C and belt speeds up to 2.5 m/s

Area of application

- Universally applicable to many types of materials such as sand, gravel, hard coal, lignite, ores, sinter, cement, conditioned refuse and dry gypsum



REMACLEAN HM-U7

Ref. No.	Designation	Belt width	Ref. No.	Designation	Belt width
578 9300	REMACLEAN HM-U7	400 mm	578 8993	REMACLEAN HM-U7 Long (310/335 mm)	800 mm
578 9301	REMACLEAN HM-U7	500 mm	578 8994	REMACLEAN HM-U7 Long (310/335 mm)	1000 mm
578 9302	REMACLEAN HM-U7	650 mm	578 8995	REMACLEAN HM-U7 Long (310/335 mm)	1200 mm
578 9303	REMACLEAN HM-U7	800 mm	578 8996	REMACLEAN HM-U7 Long (310/335 mm)	1400 mm
578 9304	REMACLEAN HM-U7	1000 mm	578 8970	REMACLEAN HM-U7 MF	400 mm
578 9305	REMACLEAN HM-U7	1200 mm	578 8971	REMACLEAN HM-U7 MF	500 mm
578 9306	REMACLEAN HM-U7	1400 mm	578 8972	REMACLEAN HM-U7 MF	650 mm
578 8990	REMACLEAN HM-U7 Long (310/335 mm)	400 mm	578 8973	REMACLEAN HM-U7 MF	800 mm
578 8991	REMACLEAN HM-U7 Long (310/335 mm)	500 mm	578 8974	REMACLEAN HM-U7 MF	1000 mm
578 8992	REMACLEAN HM-U7 Long (310/335 mm)	650 mm	578 8975	REMACLEAN HM-U7 MF	1200 mm

BELT CLEANING SYSTEMS

REMACLEAN – U-Series – for use on belt

REMACLEAN HM-U8

Belt scraper system for belt return side applications with elastically supported tungsten carbide blades and a spindle-type tension unit with reinforcement bracket, designed for heavy-duty conditions. High cleaning efficiency and long service life due to the high-quality of the carbides. Good adaptability to the conveyor belt through flexibly mounted and overlapping of the blades. Belt-protective scraper system through the segment blades dragging function.

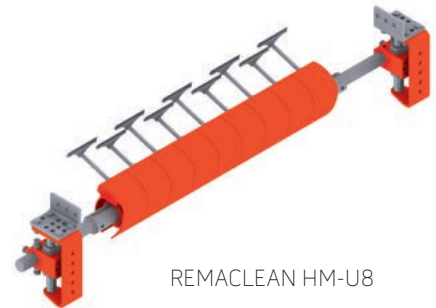

REMACLEAN HM-U8

Properties

- Belt-friendly cleaning achieved by the sagging function of the blade segments
- The tungsten carbide segments manufactured from stainless steel are individually supported, can adapt dynamically in the running direction of the belt and move 180° on its own axis
- Modular system composed of system suspension tube, carbide-blades, PUR assembly foot and spindle tensioning device with brace
- Consistent and ideal contact pressure, which is easily adjustable by using the torsion tension unit with spindle adjustment
- No tools needed for segment fitment – exchange due to clamping fastener
- Not suitable for reverse operation
- "MF" version is suitable for the use with mechanical joints
- "V" version is suitable for ATEX applications (in that case assembly feet are black)
- Version with PUR segment foot with screw mounting
- For belt widths up to 2000 mm
- Designed for service temperatures from -40 °C to +70 °C and belt speeds up to 5.5 m/s

Area of application

- Universally applicable to many types of materials such as sand, gravel, hard coal, lignite, ores, sinter, cement, conditioned refuse and dry gypsum



REMACLEAN HM-U8

Ref. No.	Designation	Belt width	Ref. No.	Designation	Belt width
578 9310	REMACLEAN HM-U8	800 mm	578 8984	REMACLEAN HM-U8 MF	1600 mm
578 9311	REMACLEAN HM-U8	1000 mm	578 8985	REMACLEAN HM-U8 MF	1800 mm
578 9312	REMACLEAN HM-U8	1200 mm	578 9450	REMACLEAN HM-U8 MF V, with ATEX approval	800 mm
578 9313	REMACLEAN HM-U8	1400 mm	578 9451	REMACLEAN HM-U8 MF V, with ATEX approval	1000 mm
578 9314	REMACLEAN HM-U8	1600 mm	578 9452	REMACLEAN HM-U8 MF V, with ATEX approval	1200 mm
578 9315	REMACLEAN HM-U8	1800 mm	578 9453	REMACLEAN HM-U8 MF V, with ATEX approval	1400 mm
578 9316	REMACLEAN HM-U8	2000 mm	578 9454	REMACLEAN HM-U8 MF V, with ATEX approval	1600 mm
578 8980	REMACLEAN HM-U8 MF	800 mm			
578 8981	REMACLEAN HM-U8 MF	1000 mm			
578 8982	REMACLEAN HM-U8 MF	1200 mm			
578 8983	REMACLEAN HM-U8 MF	1400 mm			

BELT CLEANING SYSTEMS
REMACLEAN – U-Series – for use on belt

Spare and wear parts – REMACLEAN HM-U7 / HM-U8

Ref. No.	Designation	Length
578 9441	Blade SP-U7/U8-210 Only round bar with hard metal blade.	210 mm
578 9440	Segment SEG+SP-U7-210 With hard metal blade and red polyurethane base, industrial version.	210 mm
578 9442	Blade SP-U7/U8-235 Only round bar with hard metal blade.	235 mm
578 9443	Segment SEG+SP-U7-235 With hard metal blade and red polyurethane base, industrial version.	235 mm
578 8550	Blade SP-U7/U8-310 Only round bar with hard metal blade.	310 mm
578 8551	Segment SEG+SP-U7/U8-310 With hard metal blade and red polyurethane base, industrial version.	310 mm
578 8560	Blade SP-U7/U8-335 Only round bar with hard metal blade.	335 mm
578 8561	Segment SEG+SP-U7/U8-335 With hard metal blade and red polyurethane base, industrial version.	335 mm
578 9460	Blade SP-U7/U8-210 MF Only round bar with impact-proof metal blade.	210 mm
578 9540	Segment SEG+SP-U7-210 MF With impact-proof hard metal blade and red polyurethane base, industrial version.	210 mm
578 9470	Segment SEG+SP-U7-210 MF V With impact-proof metal blade and black polyurethane base, ATEX version.	210 mm
578 9480	Blade SP-U7/U8-235 MF Only round bar with impact-proof hard metal blade.	235 mm
578 9550	Segment SEG+SP-U7-235 MF With impact-proof hard metal blade and red polyurethane base, industrial version.	235 mm
578 9490	Segment SEG+SP-U7-235 MF V With impact-proof hard metal blade and black polyurethane base, ATEX version.	235 mm
578 7750	Segment SEG+SP-U8-210	210 mm
578 7760	Segment SEG+SP-U8-210 MF	210 mm
578 7770	Segment SEG+SP-U8-210 MF V	210 mm
578 7780	Segment SEG+SP-U8-235	235 mm
578 7790	Segment SEG+SP-U8-235 MF	235 mm
578 7800	Segment SEG+SP-U8-235 MF V	235 mm



Type MF V

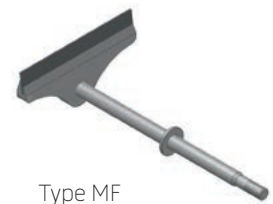

Type MF



BELT CLEANING SYSTEMS
 REMACLEAN – U-Series – for use on belt

Accessories – REMACLEAN HM-U7 / HM-U8 / HM-U11R / PUR-F5 / PUR-F5 VA

Ref. No.	Designation	For belt width	Content
578 9660	Off-set arm HM-U7/U8		1 piece
578 9610	Clamping spindle HM-U7/U8		1 piece
578 9670	Mounting bracket HM-U7/U8, hot-dip galvanized, with mounting screws		1 pair
578 8290	Tension unit HM-U7		1 pair
578 8300	Tension unit HM-U8/U11 R		1 pair
578 8160	System support bar HM-U7/U8/U11/PUR-F5	400 mm	
578 8170	System support bar HM-U7/U8/U11/PUR-F5	500 mm	
578 8180	System support bar HM-U7/U8/U11/PUR-F5	650 mm	
578 8190	System support bar HM-U7/U8/U11/PUR-F5	800 mm	
578 8200	System support bar HM-U7/U8/U11/PUR-F5	1000 mm	
578 8210	System support bar HM-U7/U8/U11/PUR-F5	1200 mm	
578 8220	System support bar HM-U7/U8/U11/PUR-F5	1400 mm	
578 8230	System support bar HM-U7/U8/U11/PUR-F5	1600 mm	
578 8240	System support bar HM-U7/U8/U11/PUR-F5	1800 mm	
578 8250	System support bar HM-U7/U8/U11/PUR-F5	2000 mm	
578 6140	System support bar HM-U7/U8/PUR-F5 VA	500 mm	
578 6150	System support bar HM-U7/U8/PUR-F5 VA	650 mm	
578 6160	System support bar HM-U7/U8/PUR-F5 VA	800 mm	
578 6170	System support bar HM-U7/U8/PUR-F5 VA	1000 mm	
578 6180	System support bar HM-U7/U8/PUR-F5 VA	1200 mm	



578 9660

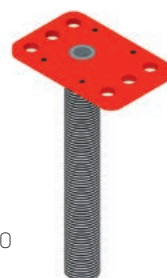

578 9610



578 9670

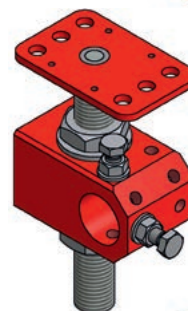

578 8290

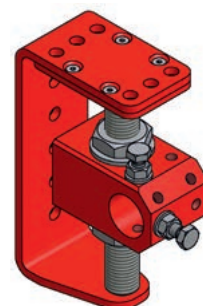

578 8300



BELT CLEANING SYSTEMS

REMACLEAN – U-Series – for use on belt

REMACLEAN HM-U9

Belt scraper system for belt return side applications with elastically supported tungsten carbide blades and a spindle-type tension unit. Comparable to HM-U6 but a more robust design. High cleaning efficiency and long service life through high-quality of the carbides. Good adaptability to the conveyor belt through flexible mounted blade segments.

Properties

- Belt-friendly cleaning achieved by the sagging function of the blade segments
- The tungsten carbide segments manufactured from stainless steel are individually supported, can adapt dynamically in the running direction of the belt
- Modular system consisting of a robust system suspension tube, carbide scrapers with PU deflectors and spindle with torsional thrust bearing
- Robust sliding deflectors made from polyethylene for the highest loads

- Low-maintenance
- Consistent and ideal contact pressure, which is easily adjustable
- Not suitable for reverse operation
- For belt widths up to 2000 mm
- Designed for service temperatures from $-40\text{ }^{\circ}\text{C}$ to $+70\text{ }^{\circ}\text{C}$ and belt speeds up to 6.5 m/s

Area of application

- Universally applicable to many types of materials such as sand, gravel, hard coal, lignite, ores, sinter, cement, clay, conditioned refuse and gypsum

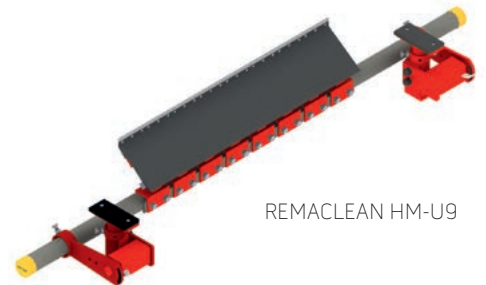

REMACLEAN HM-U9



REMACLEAN HM-U9

Ref. No.	Designation	Belt width
578 9345	REMACLEAN HM-U9	650 mm
578 9346	REMACLEAN HM-U9	800 mm
578 9348	REMACLEAN HM-U9	1000 mm
578 9349	REMACLEAN HM-U9	1200 mm
578 9350	REMACLEAN HM-U9	1400 mm
578 9351	REMACLEAN HM-U9	1600 mm
578 9352	REMACLEAN HM-U9	1800 mm
578 9353	REMACLEAN HM-U9	2000 mm

BELT CLEANING SYSTEMS

REMACLEAN – U-Series – for use on belt

REMACLEAN HM-U10

Belt scraper system for belt return side applications with elastically supported tungsten carbide blades and a spindle-type tension unit. Comparable to HM-U9 but with a spindle tensioning device. High cleaning efficiency and long service life through high-quality of the carbides. Good adaptability to the conveyor belt through flexible mounted blade segments.

Properties

- The sagging function of the blade segments ensures belt-friendly cleaning
- The tungsten carbide segments manufactured from stainless steel are individually supported, can adapt dynamically in the running direction of the belt
- Modular system composed of a robust system suspension tube, carbide-blades with apron made from polyurethane and spindle tensioning device
- Robust sliding deflectors made from polyethylene for the highest loads

- Consistent and ideal contact pressure, which is easily adjustable
- Low-maintenance
- Not suitable for reverse operation
- For belt widths up to 2200 mm
- Designed for service temperatures from $-40\text{ }^{\circ}\text{C}$ to $+70\text{ }^{\circ}\text{C}$ and belt speeds up to 6.5 m/s

Area of application

- Universally applicable to many types of materials such as sand, gravel, hard coal, lignite, ores, sinter, cement, clay, conditioned refuse and gypsum

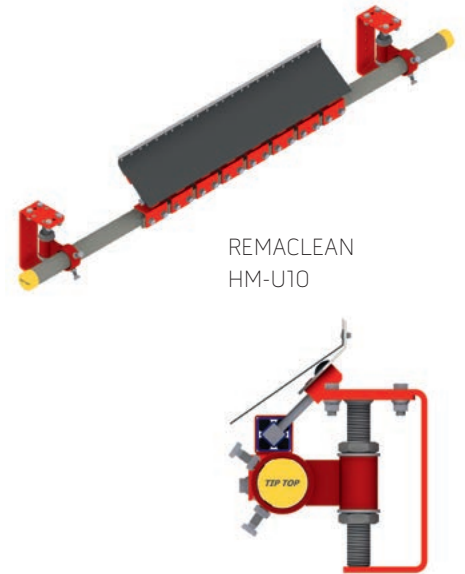

REMACLEAN
HM-U10

REMACLEAN HM-U10

Ref. No.	Designation	Belt width	Ref. No.	Designation	Belt width
578 1550	REMACLEAN HM-U10	400 mm	578 1560	REMACLEAN HM-U10	1400 mm
578 1551	REMACLEAN HM-U10	500 mm	578 1570	REMACLEAN HM-U10	1600 mm
578 1552	REMACLEAN HM-U10	650 mm	578 1580	REMACLEAN HM-U10	1800 mm
578 1553	REMACLEAN HM-U10	800 mm	578 1581	REMACLEAN HM-U10	2000 mm
578 1555	REMACLEAN HM-U10	1000 mm	578 1582	REMACLEAN HM-U10	2200 mm
578 1556	REMACLEAN HM-U10	1200 mm	578 1583	REMACLEAN HM-U10	2400 mm

Spare and wear parts – REMACLEAN HMT-U1 S, HM-U9, HM-U10

Ref. No.	Designation
5783638	Hard metal scraper segment HMT-U1 S, U9, U10, center
5781100	Hard metal scraper segment HMT-U1 S, U9, U10, right
5781090	Hard metal scraper segment HMT-U1 S, U9, U10, left

BELT CLEANING SYSTEMS

REMACLEAN – U-Series – for use on belt

REMACLEAN HM-U11 R

Belt scraper system for belt return side applications with elastically supported tungsten carbide blades and a spindle-type tension unit suited for reverse operation. High cleaning efficiency and long service life through high-quality of the carbides. Good adaptability to the conveyor belt through flexible mounted blade segments.

Properties

- The sagging function of the blade segments ensures belt-friendly cleaning
- The tungsten carbide segments manufactured from stainless steel are individually supported, can adapt dynamically in the running direction of the belt
- Modular system consisting of a robust system suspension tube, carbide blades, foot made from soft polyurethane and a spindle mounting system
- Robust sliding deflectors made from polyethylene for the highest loads
- Consistent and ideal contact pressure, which is easily adjustable
- Low-maintenance
- System carrier is protected with sliding aprons of the PUR foot
- Version with PUR segment foot with screw mounting
- Particularly suited for reverse operation
- For belt widths up to 2000 mm

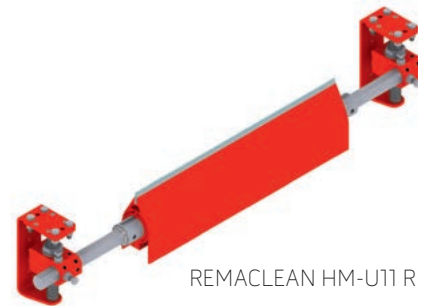

REMACLEAN HM-U11 R

- Designed for service temperatures from $-40\text{ }^{\circ}\text{C}$ to $+70\text{ }^{\circ}\text{C}$ and belt speeds up to 6.5 m/s

Area of application

- Universally applicable to many types of materials such as sand, gravel, hard coal, lignite, ores, sinter, cement, clay, conditioned refuse and gypsum

REMACLEAN HM-U11 R

Ref. No.	Designation	Belt width	Ref. No.	Designation	Belt width
578 1800	REMACLEAN HM-U11 R	400 mm	578 1850	REMACLEAN HM-U11 R	1200 mm
578 1810	REMACLEAN HM-U11 R	500 mm	578 1860	REMACLEAN HM-U11 R	1400 mm
578 1820	REMACLEAN HM-U11 R	650 mm	578 1870	REMACLEAN HM-U11 R	1600 mm
578 1830	REMACLEAN HM-U11 R	800 mm	578 1880	REMACLEAN HM-U11 R	1800 mm
578 1840	REMACLEAN HM-U11 R	1000 mm	578 1890	REMACLEAN HM-U11 R	2000 mm

Spare and wear parts – REMACLEAN HM-U11 R

Ref. No.	Designation	Width
578 1900	Segment SEG+SP-U11 R	120 mm



BELT CLEANING SYSTEMS

REMACLEAN – U-Series – for use on belt

REMACLEAN HM-U500

REMACLEAN HM-U500 is a belt cleaning system for belt return side applications in large conveyor systems with elastically supported tungsten carbide blades and a spindle-type tension unit. The segments are individually mounted to the system suspension tube and the carbide blades are mounted in polyurethane feet in such a way that they can turn. Thus, they adapt to the conveyor belt in the best way possible and ensure effective cleaning

Properties

- Belt-friendly cleaning achieved by the sagging function of the blade segments
- The tungsten carbide segments manufactured from stainless steel are individually supported, can adapt dynamically in the running direction of the belt and move 180° on its own axis
- Modular system consisting of a robust system suspension tube, carbide blades, foot made from soft polyurethane and a spindle mounting system
- Robust sliding deflectors made from polyethylene for the highest loads
- Consistent and ideal contact pressure, which is easily adjustable
- Low-maintenance
- System carrier is protected with sliding aprons of the PUR foot
- Each polyurethane foot is equipped with supporting springs, which resist dynamic loads
- For belt widths up to 3000 mm
- Designed for service temperatures from -40 °C to +70 °C and belt speeds up to 10.0 m/s

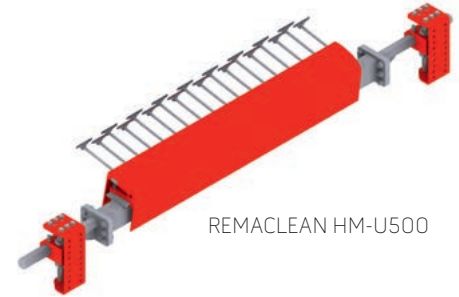

REMACLEAN HM-U500

Area of application

- Universally applicable to many types of materials such as sand, gravel, hard coal, lignite, ores, sinter and cement

REMACLEAN HM-U500

Ref. No.	Designation	Belt width
578 5890	REMACLEAN HM-U500	1400 mm
578 5891	REMACLEAN HM-U500	1600 mm
578 3970	REMACLEAN HM-U500	1800 mm
578 5880	REMACLEAN HM-U500	2000 mm

Spare and wear parts – REMACLEAN HM-U500

Ref. No.	Designation	Length
578 8580	Blade SP-U500-350 Only round bar with hard metal blade.	350 mm
578 8570	Blade SP-U500-375 Only round bar with hard metal blade.	375 mm

BELT CLEANING SYSTEMS

REMACLEAN – Belt Cleaning Brushes

REMACLEAN GRB

REMACLEAN GRB with round rubber fingers and an electric extern drive for the fine cleaning of the carrier-side of the conveyor belt behind or under the discharge pulley. The rubber fingers optimally adapt to the belt surface and guarantee effective and belt-friendly cleaning.

Properties

- Cleaning brush direct drive through an electric motor
- Highly flexible and extremely gentle on the belt due to rubber fingers
- Speed: 1000 rpm
- Voltage: 400 V, 50 Hz (other versions available on request)
- Protective system: B3, IP55
- Motor capacity BB 400 - 500: 0.55 kW
- Motor capacity BB 600 - 1 000: 0.75 kW

- Motor capacity BB 1200 - 1 600: 1.1 kW
- Motor capacity BB 1800 - 2 000: 1.5 kW
- Designed for belt speeds up to 2.5 m/s
- A version suitable for ATEX applications is available on request

Area of application

- Universally suitable for removing fine and pulverised as well as slightly adhering materials; to be combined with a pre-scraper for moist materials

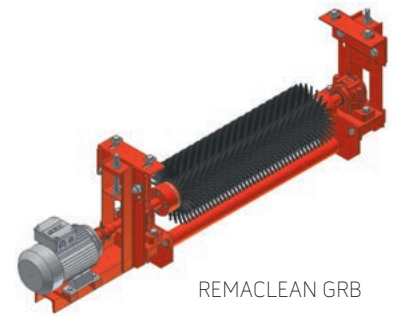

REMACLEAN GRB

Specifications

Polymer basis	NR	DIN ISO 1629
Hardness	49 Shore A	DIN ISO 7619-1
Colour	Black	

Ref. No.	Designation	Belt width
578 5007	REMACLEAN GRB	400 mm
578 5014	REMACLEAN GRB	500 mm
578 5021	REMACLEAN GRB	650 mm
578 5038	REMACLEAN GRB	800 mm
578 5045	REMACLEAN GRB	1000 mm
578 5052	REMACLEAN GRB	1200 mm
578 5069	REMACLEAN GRB	1400 mm
578 5076	REMACLEAN GRB	1600 mm
578 5083	REMACLEAN GRB	1800 mm
578 5090	REMACLEAN GRB	2000 mm

BELT CLEANING SYSTEMS

REMACLEAN – Belt Cleaning Brushes

Spare cleaning brush GRB

Consists of shaft made from steel with attached rubber bristles in standard quality. Versions with rubber bristles in food quality or self-extinguishing quality available on request.

Ref. No.	Designation	Belt width
578 4400	REMACLEAN spare cleaning brush GRB	400 mm
578 4417	REMACLEAN spare cleaning brush GRB	500 mm
578 4424	REMACLEAN spare cleaning brush GRB	650 mm
578 4431	REMACLEAN spare cleaning brush GRB	800 mm
578 4448	REMACLEAN spare cleaning brush GRB	1000 mm
578 4455	REMACLEAN spare cleaning brush GRB	1200 mm
578 4462	REMACLEAN spare cleaning brush GRB	1400 mm
578 4479	REMACLEAN spare cleaning brush GRB	1600 mm
578 4486	REMACLEAN spare cleaning brush GRB	1800 mm
578 4493	REMACLEAN spare cleaning brush GRB	2000 mm



Spare cleaning brush GRB

Rubber bristle GRB

Ref. No.	Designation	Dimensions
529 7100	Rubber bristle standard, black, Hardness 48 Shore A	745 x 297 mm
527 2723	Rubber bristle WHITE FOOD, white, Hardness 40 Shore A Food quality in accordance with: <ul style="list-style-type: none"> Federal Institute for Risk Assessment, Recommendations on Food Contact Materials XXI, Cat. 3+4 (Germany) Regulation (EU) No. 1935/2004 FDA Regulation No. 21 CFR 177.2600 	745 x 297 mm
527 2716	Rubber bristle V, black, Hardness 62 Shore A Self-extinguishing, moderately oil and grease resistant	745 x 297 mm

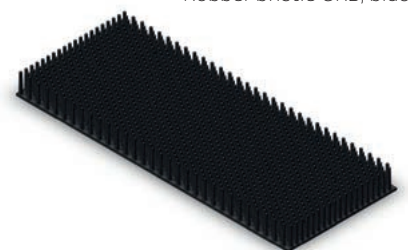

Rubber bristle GRB, black

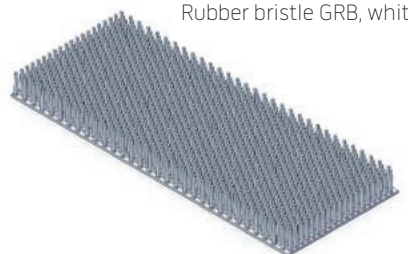

Rubber bristle GRB, white

BELT CLEANING SYSTEMS

REMACLEAN – Belt Cleaning Brushes

Shaft set GRB

Please state the belt width when ordering.

Ref. No.	Designation	Belt width
578 4840	Shaft set GRB	400 - 1000 mm
578 4850	Shaft set GRB	1200 - 2000 mm



Tschan coupling GRB

Please state the belt width when ordering.

Ref. No.	Designation	Belt width
578 6700	REMACLEAN tschan coupling S 50	400 - 2000 mm
578 6710	REMACLEAN star, for REMACLEAN tschan coupling S 50	400 - 2000 mm

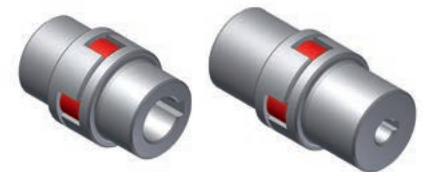

BELT CLEANING SYSTEMS

REMACLEAN – Belt Cleaning Brushes

REMACLEAN TMB

REMACLEAN TMB is a conveyor belt cleaning system with plastic bristles and internally located drive for fine cleaning of the conveyor belt carrier-side.

Properties

- Cleaning brush with direct electric motor drive
- Highly flexible and extremely gentle on the belt due to plastic bristles
- Drum motor: 400 V, 50 Hz (other versions available on request)
- Motor capacity BB 400 - 800: 1.1 kW
- Motor capacity BB 900 - 2 000: 1.5 kW
- Self-cleaning
- Very compact construction through the drum motor
- All electric motors fall into protection class IP66
- Also available in version suitable for use in ex-zones (Device Group II Category 3D T135 °C) also available for food processing and in an oil resistant version

- Available with stainless steel motor
- Suitable for reverse operation; the motor must be switched over to correspond with the direction of operation
- Designed for service temperatures from -40 °C to +70 °C and belt speeds up to 6.5 m/s

Area of application

- Universally suitable for removing fine and pulverised as well as slightly adhering materials; to be combined with a pre-scraper for moist materials



REMACLEAN TMB

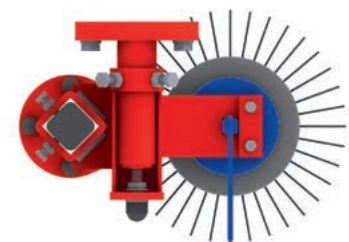

REMACLEAN TMB

Ref. No.	Designation	Belt width
578 0590	REMACLEAN TMB	400 mm
578 0600	REMACLEAN TMB	500 mm
578 4802	REMACLEAN TMB	650 mm
578 0617	REMACLEAN TMB	800 mm
578 0631	REMACLEAN TMB	1000 mm
578 0648	REMACLEAN TMB	1200 mm
578 0916	REMACLEAN TMB	1400 mm
578 0915	REMACLEAN TMB	1600 mm
578 0970	REMACLEAN TMB	1800 mm
578 0971	REMACLEAN TMB	2000 mm

BELT CLEANING SYSTEMS
 REMACLEAN – Belt Cleaning Brushes

Spare and wear parts – REMACLEAN TMB

Ref. No.	Designation	Belt width
578 0810	REMACLEAN brush set TMB	400 mm
578 0827	REMACLEAN brush set TMB	500 mm
578 0834	REMACLEAN brush set TMB	650 mm
578 0841	REMACLEAN brush set TMB	800 mm
578 0865	REMACLEAN brush set TMB	1000 mm
578 0872	REMACLEAN brush set TMB	1200 mm
578 0899	REMACLEAN brush set TMB	1400 mm
578 0804	REMACLEAN brush set TMB	1600 mm
578 0805	REMACLEAN brush set TMB	1800 mm
578 0906	REMACLEAN individual brush segment TMB	100 mm
578 0889	REMACLEAN locking ring, for brush set TMB	up to 800 mm
578 1050	REMACLEAN brush segment TMB, 226 mm	from 1000 mm
578 1060	REMACLEAN endpiece TMB, 157 mm	from 1000 mm

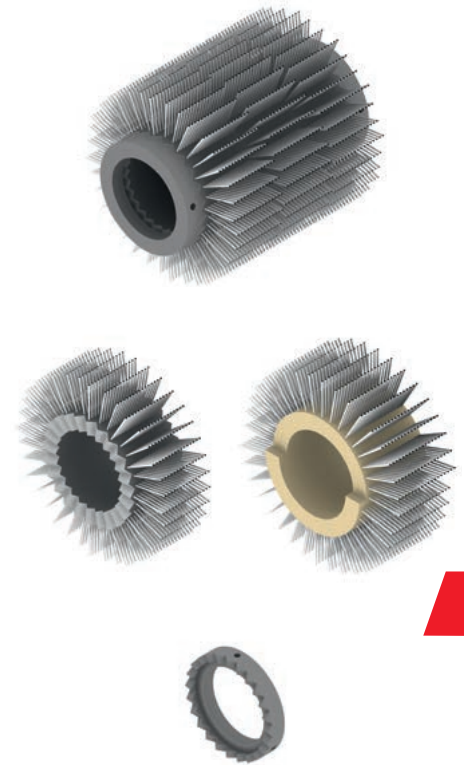

BELT CLEANING SYSTEMS

REMACLEAN – Belt Cleaning Brushes

REMACLEAN SGB

REMACLEAN SGB is a belt cleaning system with rubber bristles for fine cleaning of the carrier-side of a belt with CHEVRON profile.

Properties

- Electric motor cleaning brush with bevel gear drive
- Cleat height max. 24 mm
- Highly flexible and extremely gentle on the belt due to rubber bristles with a hardness 64 Shore A
- Drum motor: 230 - 400 V, 50 Hz (other versions available on request)
- Motor capacity BB 400 - 800: 1.1 kW
- Motor capacity BB 900 - 1050: 1.5 kW
- Motor capacity BB 1000 - 1400: 2.2 kW
- Self-cleaning
- Compact construction
- All electric motors fall into protection class IP55

- Also available in a version suitable for use in ex-zones (Device Group II Category 3D T135 °C) zone from 22
- Also available with bristles in V quality
- Suitable for reverse operation; the motor must be switched over to correspond with the direction of operation
- Designed for service temperatures from -40 °C to +70 °C and belt speeds up to 2.5 m/s

Area of application

- Universally applicable removing sticky material such as sand, gravel, hard coal, cement, ores, lignite, conditioned refuse and sinter from conveyor belts with CHEVRON profile

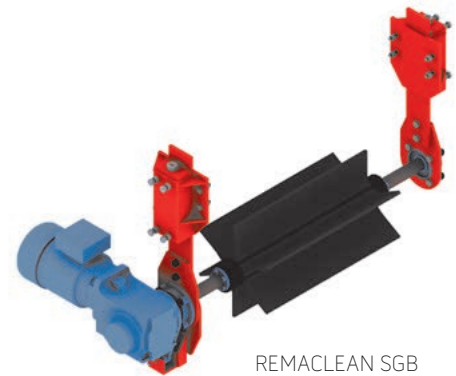

REMACLEAN SGB



REMACLEAN SGB

Other belt widths on request.

Ref. No.	Designation	Belt width
578 0655	REMACLEAN SGB	400 mm
578 0662	REMACLEAN SGB	500 mm
578 0679	REMACLEAN SGB	650 mm
578 0686	REMACLEAN SGB	800 mm
578 0703	REMACLEAN SGB	1000 mm
578 0710	REMACLEAN SGB	1200 mm
578 0727	REMACLEAN SGB	1400 mm

BELT CLEANING SYSTEMS
REMACLEAN – Belt Cleaning Brushes

Spare cleaning brush SGB

Ref. No.	Designation	Belt width
578 0734	Spare cleaning brush SGB	400 mm
578 0741	Spare cleaning brush SGB	500 mm
578 0758	Spare cleaning brush SGB	650 mm
578 0765	Spare cleaning brush SGB	800 mm
578 0789	Spare cleaning brush SGB	1000 mm
578 0796	Spare cleaning brush SGB	1200 mm
578 0803	Spare cleaning brush SGB	1400 mm



Spare cleaning brush SGB

BELT CLEANING SYSTEMS

REMACLEAN – Belt Return Side Scraper

REMACLEAN RB-IGP plough scraper

Plough scraper for return side applications at the running side to protect the pulley from material. The frame construction levels off the belt and thus guarantees optimum alignment of the scraper and ensures efficient cleaning. The required contact pressure is created by the weight of the system. An auxiliary wheel mounted on the scraper prevents contact of the steel frame with the belt surface after the rubber bar is worn out.

Properties

- Highly compact construction
 - Base frame with suspension rollers and plough scraper (rubber lip consists of REMACLEAN CAB)
 - A version for underground use is also available (ATEX-suitable)
 - Not suited for reverse operation
 - For belt widths up to 2000 mm
- Designed for service temperatures from $-40\text{ }^{\circ}\text{C}$ to $+70\text{ }^{\circ}\text{C}$ and belt speeds up to 3.5 m/s

Area of application

- Universally applicable to many types of materials such as sand, gravel, hard coal, cement, ores, lignite, refuse, clay and sinter



REMACLEAN RB-IGP

REMACLEAN RB-IGP

Ref. No.	Designation	Belt width
578 1300	REMACLEAN RB-IGP	500 mm
578 1310	REMACLEAN RB-IGP	650 mm
578 1320	REMACLEAN RB-IGP	800 mm
578 1330	REMACLEAN RB-IGP	1000 mm
578 1340	REMACLEAN RB-IGP	1200 mm
578 1350	REMACLEAN RB-IGP	1400 mm
578 1360	REMACLEAN RB-IGP	1600 mm
578 1363	REMACLEAN RB-IGP	1800 mm
578 1290	REMACLEAN RB-IGP	2000 mm

BELT CLEANING SYSTEMS

REMACLEAN – Belt Return Side Scraper

REMACLEAN RB-IGP V

Self-extinguishing, antistatic and moderate oil resistant scraper bar in LOBA quality for underground applications.

Ref. No.	Designation	Belt width
578 1301	REMACLEAN RB-IGP V	500 mm
578 1311	REMACLEAN RB-IGP V	650 mm
578 1321	REMACLEAN RB-IGP V	800 mm
578 1331	REMACLEAN RB-IGP V	1000 mm
578 1341	REMACLEAN RB-IGP V	1200 mm
578 1351	REMACLEAN RB-IGP V	1400 mm
578 1361	REMACLEAN RB-IGP V	1600 mm



REMACLEAN RB-IGP V

BELT CLEANING SYSTEMS

REMACLEAN – Belt Return Side Scraper

REMACLEAN RB-IGD diagonal scraper

Diagonal scraper for return side applications at the running side to protect the pulley from material. The required contact pressure is achieved by the spindle-type tension unit.



REMACLEAN RB-IGD

Properties

- Highly compact construction with a spindle-type tension unit (rubber lip consists of REMACLEAN CAB)
- A version for underground use is also available (ATEX-suitable)
- Suited for reverse operation
- For belt widths up to 2000 mm

- Designed for service temperatures from -40 °C to +70 °C and belt speeds up to 3.5 m/s

Area of application

- Universally applicable to many types of materials such as sand, gravel, hard coal, cement, ores, lignite, refuse, clay and sinter



REMACLEAN RB-IGD

Ref. No.	Designation	Belt width
578 1370	REMACLEAN RB-IGD	400 mm
578 1380	REMACLEAN RB-IGD	500 mm
578 1390	REMACLEAN RB-IGD	650 mm
578 1400	REMACLEAN RB-IGD	800 mm
578 1410	REMACLEAN RB-IGD	1000 mm
578 1420	REMACLEAN RB-IGD	1200 mm
578 1430	REMACLEAN RB-IGD	1400 mm
578 1440	REMACLEAN RB-IGD	1600 mm
578 1450	REMACLEAN RB-IGD	1800 mm
578 1460	REMACLEAN RB-IGD	2000 mm

BELT CLEANING SYSTEMS

REMACLEAN – Belt Return Side Scraper

REMACLEAN RB-IGD V

Self-extinguishing, antistatic and moderate oil resistant scraper bar in LOBA quality for underground applications.



REMACLEAN RB-IGD V

Ref. No.	Designation	Belt width
578 1371	REMACLEAN RB-IGD V	400 mm
578 1381	REMACLEAN RB-IGD V	500 mm
578 1391	REMACLEAN RB-IGD V	650 mm
578 1401	REMACLEAN RB-IGD V	800 mm
578 1411	REMACLEAN RB-IGD V	1000 mm
578 1421	REMACLEAN RB-IGD V	1200 mm
578 1431	REMACLEAN RB-IGD V	1400 mm
578 1441	REMACLEAN RB-IGD V	1600 mm





● CONVEYOR COVER SYSTEMS



REMA TIP TOP



Dust sealing systems

184-186

CONVEYOR COVER SYSTEMS

Dust sealing systems

REMADUST dust sealing blankets

REMADUST is a dust sealing system which minimises dust emissions and reduces noise levels. The blankets are made of REMALINE 25 material with textile grid pattern on both sides and are characterised by high levels of elasticity and rupture strength. Its long-lasting weather-resistance means it can be used in a wide range of industrial sectors. This means REMADUST can guarantee virtually dust-free operation in many conveyor and processing systems and increase profitability by reducing maintenance and assembly costs.

Properties

- Significant reduction of dust content
- Highly elastic
- High tear growth resistance
- Good resistance to weather
- Simple to fit using clamping profiles
- Minimal maintenance costs
- Reduced amount of extraction air required
- Considerable sound reduction

Area of application

- Minimises problems with dust in screening machines, conveyor systems and other bulk materials transport installations

REMADUST 25

Specifications

Polymer basis	NR/IR	DIN ISO 1629
Specific weight	0.97 g/cm ³	DIN EN ISO 1183-1
Hardness	33 Shore A	DIN ISO 7619-1
Colour	Black	

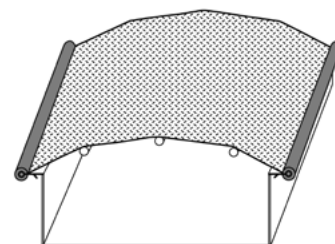

Ref. No.	Designation	Dimensions
549 4439	REMADUST 25	2 x 1350 x 20 000 mm

CONVEYOR COVER SYSTEMS
Dust sealing systems

TT clamping profiles

Mounting on 10 mm round steel. External $\varnothing = 31$ mm for clamping profiles: radius to center of groove is 55 mm.



TT clamping profiles

Ref. No.	Designation	Dimensions	Bend angle	Content
549 4446	TT clamping profile			35 m roll
549 4453	TT 90° corner clamping profile, internal groove	205 x 205 mm	90°	
549 4460	TT 90° corner clamping profile, external groove	205 x 205 mm	90°	
549 4477	TT 90° corner clamping profile, groove on underside	205 x 205 mm	90°	

CONVEYOR COVER SYSTEMS

Dust sealing systems

REMADUST CCS (Conveyor Cover System)

The REMA TIP TOP cover system offers a fast and effective solution for the enclosure of conveyor belts of any size. Due to its simple construction, the system can easily be fitted to both existing and new conveyors. The frame arches are simply bolted or welded to the conveyor frame and the plastic tarp placed over these, entirely covering the belt. This way, material losses due to wind are effectively avoided and the belt is protected against the effects of weather.

Properties

Mounting frame:

- Zinc-plated metal bows for frame
- Simple and fast attachment on conveyor frame

Cover:

- UV-stable and resistant to weather influences
- Standard material (impregnated PVC fabric) suitable for use from -20 °C to +60 °C
- Easy access to belt from both sides; cover can be fixed in open position
- Fast attachment and opening due to quick fasteners (can be carried out by one person without problems)
- Cover and frame (bolted variant) can be quickly removed for inspection and maintenance work
- System can be retrofitted to existing belt conveyors

- Emission protection requirements can be fulfilled quickly and cost-effectively
- Standard dimensions per element: 1000 mm
- No "sheet metal noises", no change due to rust

Area of application

- Prevents problems due to dust in conveyor systems and other bulk materials transport systems
- Protects conveyor belt system and bulk materials being transported against weather influences

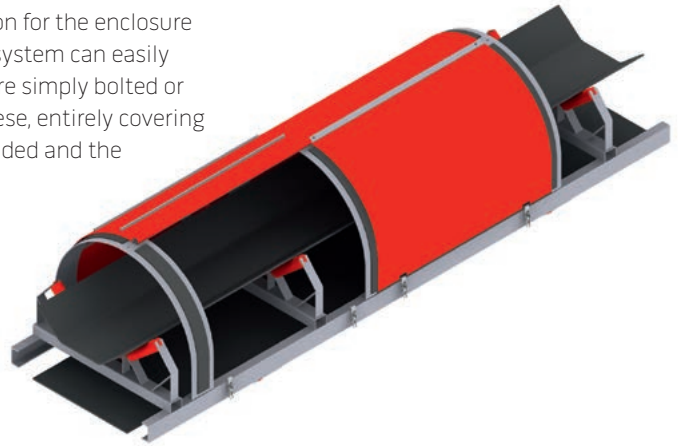

* (Various sizes or special versions of this item are available on request.) A detailed inquiry form is attached.

MILL LINING



REMA TIP TOP



REMAMILL

188

REMAMILL mill lining

REMAMILL mill lining reduces operating costs and increases productivity. The individual design of the lining, adapted to each customer's needs, improves mill efficiency and output many times over and thereby significantly cuts energy costs. Highly wear-resistant elastomer materials prolong service-life and reduce noise considerably.

Properties

- Highly abrasion-resistant
REMAMILL 70 rubber (up to 70 °C)
- Heat resistant REMAMILL 70 HR
rubber (up to 90 °C)

Area of application

- Autogenous (AG) mills
- Semi-autogenous (SAG) mills
- Ball mills
- Pebble mills
- Rod tube mills
- Ceramic mills (salt mills, continuous mills)
- Washing and slurry drums
- Bark peeling drums

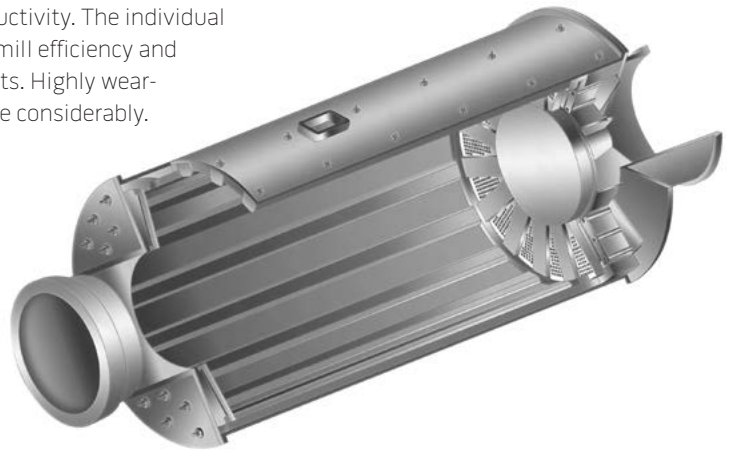

Lifter bars

- Transport of grinding media and the material to be milled
- Beveled for optimal cataract effect
- Fastening of shell plates
- Fastening profile made for the specific purpose of aluminium or steel



Shell plates

- Wear protection for the mill shell
- Fastening lips made of steel or rubber
- Fixed by lifters

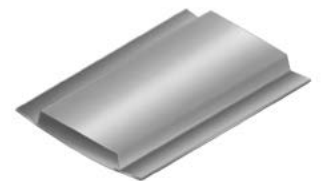

Head plates

- Lining of the head or shell
- Fastening lips made of steel or rubber
- Fixed by lifters



Grate plate

- Sifting of crushed material
- Fastening lips made of steel or rubber
- Fixed by lifters, self-centring chuck, pulp lifters and connecting profile



End profiles and filling segments

- Transition between the shell and head lining
- Multiple parts for easier installation



Discharger

- Transport of milled material
- Steel construction with high-quality vulcanized rubber wear protection



Center cone

- Central material discharge element
- Steel construction with high-quality vulcanized rubber wear protection

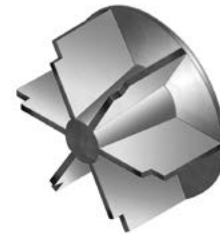

Manhole cover

- Manhole cover with adapted lifter and shell plates
- Form made of steel with high-quality vulcanized rubber wear protection
- Adjusted lifters and shell plates screwed on manhole lid



TT-Fastening System

- TT-Fastening System: Consists of forged TT bolts with washer, elastomer seal and self-locking nut
- Clamp Block Fastening System: Consists of clamp block with washer, elastomer seal and self-locking nut



Clamp Block Fastening System



TT-Fastening System

Information on the various sizes and profile versions of all items is available on request. A detailed questionnaire is included in the enclosures.

MATERIAL HANDLING HOSE SYSTEMS



REMA TIP TOP



Slurry handling hoses

192

Couplings

193

Gaskets

194

MATERIAL HANDLING HOSE SYSTEMS

Slurry handling hoses

DUNLOP HD slurry handling hoses – For hydraulic operation

DUNLOP HD slurry handling hoses have been designed to withstand heavy-duty operating conditions and are a convincing choice due to their highly wear-resistant inner tube layer (40 Shore A) with a smooth surface and a low flow resistance. A special cord and a fully embedded galvanized steel wire spiral provide additional reinforcement, the smooth outer tube optimum resistance to wear and weather. In combination with REMA TIP TOP split flange couplings and REMA TIP TOP gaskets, DUNLOP HD slurry handling hoses can be easily adjusted to different lengths and offer a complete material handling system universally applicable to many types of materials with high reliability.

Properties

- Red NR-wear protection inner tube layer
- Highly resistant against wear and abrasion
- Avoidance of leaks and point areas of wear
- Quick and easy installation without special tools
- Can be cut to length on-site
- Also suitable for bends
- Reduces operating costs
- Long service life
- Noise damping
- Reduces vibration

- Good weather resistance
- Marking: red vulcanette
- Applicable for temperatures from -35 °C to +70 °C
- Bursting pressure of 3.2 fold operating pressure

Area of application

- Hydraulic delivery and suction operation for abrasive slurry (stones and sand with lump size of up to 10 mm)
- To be used as compensation tube for steel pipes under thermal expansion



DUNLOP HD slurry handling hoses

DUNLOP HD slurry handling hoses

Ref. No.	ID in mm	ID in inches	OD in mm	Thickness of inner tube layer in mm	Min. bending radius in mm	Weight in kg/m	Standard length in mm	Working pressure in Mpa	Vacuum in %
537 8000	76	3.00	99.5	6	450	4.1	20	1	90
537 8001	102	4.00	125	6	600	5.4	20	1	90
537 8002	127	5.00	154	6	750	7.5	10	1	90
537 8003	152	6.00	178	6	900	8.9	10	1	90
537 8004	204	8.00	238	7.5	1300	16.2	10	1	90
537 8005	254	10.00	291	7.5	1600	21.3	10	0.7	50
537 8006	305	12.00	341	7.5	1800	27.5	10	0.7	50
537 8007	355	14.00	403	12	2200	4.8	10	0.7	50

Other dimensions, 3-D rubber bends, reducers, Y-pieces and fixing clamps on request.

MATERIAL HANDLING HOSE SYSTEMS

Couplings

REMA TIP TOP split flange couplings – For DUNLOP HD slurry handling hoses

REMA TIP TOP split flange couplings are especially designed for DUNLOP HD slurry handling hoses. The couplings are made of high strength aluminum alloys and consist of two or four identical segments which are mounted mechanically on the smooth hose. Since they do not come into contact with the transported materials, the couplings are reusable after replacing.



Split flange couplings

Properties

- No wear on couplings
- Quick and easy installation without special tools
- Low weight due to high strength aluminum alloy
- Reusable, reduces operating costs
- Good weather resistance
- Suitable for all common standard flange drillings (DIN, ANSI)

Area of application

- Connecting element for use with DUNLOP HD hoses and bends for slurry handling in heavy wear applications

Ref. No.	Flange size in mm	Flange size in inches	For hoses ID in mm	OD coupling in mm	Diameter min. - max. in mm	No. of drill holes	No. of segments in pcs	Weight in kg/pcs	Suitable for standard flange drilling					
									DIN 2632 PN10	BS10	BS4504 10/3 & 16/3	SABS 1123 1000/3	ASME/ANSI B16.1	
5378100	76	3"	76	195	147-171	4	2	1.7	X	X	–	X	X	X
5378101	102	4"	102	217	178-192	4	2	2.7	X	X	–	X	X	X
5378102	127	5"	127	254	200-229	8	2	3.5	X	X	–	X	X	X
5378103	152	6"	152	278	235-250	8	2	5.3	X	X	X	X	X	X
5378104	204	8"	204	338	295-310	8	2	9.4	X	X	X	X	X	X
5378105	254	10"	254	402	350-374	8	2	11.5	X	X	X	X	X	X
5378106	305	12"	305	477	400-445	12	2	17	X	X	X	–	X	–
5378107	355	14"	355	526	445-470	12	4	22.5	X	X	X	–	X	–

Other dimensions and alloys on request.

MATERIAL HANDLING HOSE SYSTEMS

Gaskets

REMA TIP TOP gaskets – For DUNLOP HD slurry handling hoses

REMA TIP TOP gaskets are made of highly wear-resistant polyurethane especially designed for DUNLOP HD material handling hoses. In combination with REMA TIP TOP split flange couplings, the gaskets offer a secure and reliable connection against leakage between hose components, hose bends, hoses and lined pipes.

Properties

- No turbulences
- Quick and easy installation without special tools
- Low weight
- Good chemical resistance

Area of application

- Sealing for use with REMA TIP TOP couplings and DUNLOP HD slurry handling hoses and bends



Gasket

Gaskets, for DUNLOP HD slurry handling hoses

Ref. No.	Dimensions	For hoses ID	Weight in kg/pcs
537 8200	76 mm	76 mm	0.1
537 8201	102 mm	102 mm	0.15
537 8202	127 mm	127 mm	0.2
537 8203	152 mm	152 mm	0.25
537 8204	204 mm	204 mm	0.4
537 8205	254 mm	254 mm	0.6
537 8206	305 mm	305 mm	0.7
537 8207	355 mm	355 mm	0.75

Other dimensions on request.

CLEATS AND SIDEWALLS

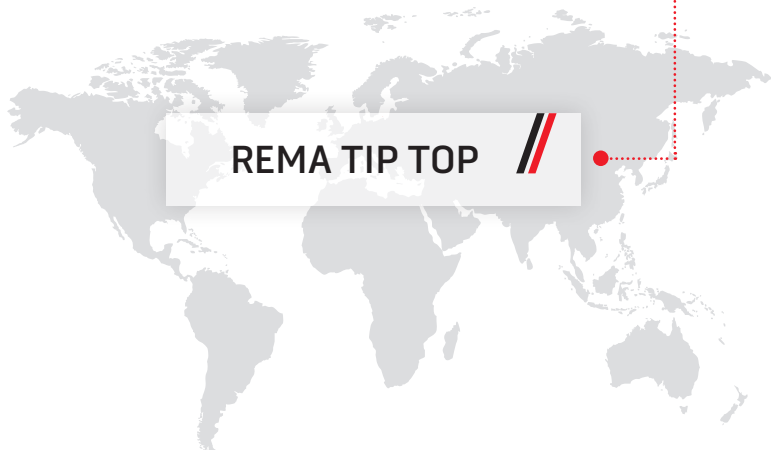

REMA TIP TOP



REMAWELL

196-197



CLEATS AND SIDEWALLS REMAWELL

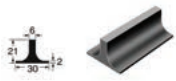

533 8021

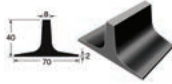

533 8069



533 8083

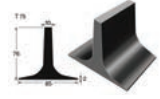

533 8124



533 8045

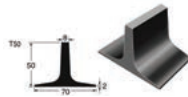

533 8090



533 8117

Rubber cleats and corrugated edges

REMACLEAT – Rubber cleats

These rubber cleats have a black contact layer protected by a thin fabric. Rubber cleats may be cut to the desired length for processing. Remove the fabric just prior to application of adhesive. If the contact layer is dirty or if the protective fabric is removed more than 2 hours prior to applying the adhesive, the cleats must be buffed and 2 layers of adhesive must be applied.

Specifications

Polymer basis	SBR	DIN ISO 1629
Specific weight	1.14 g/cm ³	DIN EN ISO 1183-1
Hardness	64 Shore A	DIN ISO 7619-1
Colour	Black	

Ref. No.	Designation	Height	Dimensions	Qty
533 8021	REMACLEAT T 20	20 mm	Base: 30 x 2000 mm	5
533 8045	REMACLEAT T 30	30 mm	Base: 40 x 2000 mm	5
533 8069	REMACLEAT T 40	40 mm	Base: 70 x 2000 mm	5
533 8090	REMACLEAT T 50	50 mm	Base: 70 x 2000 mm	5
533 8083	REMACLEAT TD 50	50 mm	Base: 70 x 2000 mm	5
533 8117	REMACLEAT TS 60	60 mm	Base: 75 x 2000 mm	5
533 8124	REMACLEAT T 75	75 mm	Base: 85 x 2000 mm	5

CLEATS AND SIDEWALLS REMAWELL

Corrugated rubber edge

Available in lengths of up to 50 m. Buffing required before applying adhesive.

Ref. No.	Designation	Dimensions
574 2290	Corrugated rubber edge WK40	Base width: 40 mm
574 2291	Corrugated rubber edge WK60	Base width: 50 mm
574 2292	Corrugated rubber edge WK80	Base width: 50 mm
574 2293	Corrugated rubber edge WK100	Base width: 50 mm
574 2294	Corrugated rubber edge WK120	Base width: 50 mm



Corrugated rubber edge

● CONVEYOR BELTING
Manufactured by DUNLOP
Belting Products (Pty) Ltd.
Lincoln Road · Benoni 1500
South Africa



REMA TIP TOP



DBP Dunlop Belting Products

200-201

REMA TIP TOP PORTFOLIO CONVEYOR BELTING
DBP Dunlop Belting Products

Description	Properties	Carcass	Min. breaking strength	Cover	Further options
DBP WearTECH	Wear-resistant	EP	315 - 2500	AA* - W/D - X/H - Y	
		PP	800 - 2500		
		ST	500 - 5400		
DBP LavaTECH	Heat-resistant 150 - 220 °C	EP	315 - 2500	T1-150° / T2-220°	
		ST	500 - 5400		
DBP OilTECH	Oil and grease resistant	EP	315 - 2500	G/G+/G	
		ST	500 - 5400		
DBP FlameTECH	Flame-resistant according to ISO 340 DBP-LEVEL 1	EP	315 - 2500	K/S/G1	DBP AntiripTECH DBP Self-AdjustTECH DBP CrossTECH
		ST	500 - 5400		
	Flame-resistant /Self-extinguishing according to DIN EN 12882 surface DBP-LEVEL 2	EP	315 - 2500	Fire-resistant	
		ST	500 - 5400		
	Flame-resistant /Self-extinguishing according to DIN EN 14973 underground DBP-LEVEL 3	EP	315 - 2500	Fire-resistant	
		ST	500 - 5400		
DBP ForceTECH	Aramide fabric conveyor belts	D	400 - 3150	All categories	
DBP LiftTECH	ELEVATOR conveyor belts	EP	315 - 2500	All categories	
		ST	500 - 5400		
DBP FlowTECH	PIPE conveyor belts	EP	315 - 2500	All categories	
		ST	500 - 5400		
DBP SlideTECH	Sliding conveyor belt	EP	315 - 2500	All categories	
DBP FlexTECH	FLEX-conveyor belts	EPP	400 - 2500	All categories	
DBP SolidTECH	SOLID WOVEN conveyor belts	EP/B/PB	630 - 3150	AA* - W/D - X/H - Y	
DBP ChevronTECH	Steep-incline belts	EP	400 - 1000	All categories	
DBP REMAWELL	Sidewall conveyor belts	EP	400 - 2000	All categories	
		ST	500 - 5400		

Belting portfolio manufactured by
Dunlop Belting Products (PTY) LTD
Lincoln Road, Benoni 1500,
South Africa

REMA TIP TOP PORTFOLIO CONVEYOR BELTING
DBP Dunlop Belting Products

Range of qualities

Cover	Cover classification		Temperature range °C			Polymer basis
	Abrasion < mm ³	Elongation at break min. in %	Min. ambient temperature	Constant material temperature	Max. temporary material temperature	
AA*	130	400	-30	80	90	SBR
Y	150	400	-30	80	100	SBR
X/H	120	450	-40	80	90	NR
W/D	90	400	-30	80	90	NR/SBR
T1	200	400	-20	150	170	SBR
T2	200	400	-20	200	220	EPDM
G	130	400	-20	80	90	SBR/NBR
G+	130	400	-20	80	90	NBR
G1	170	450	-20	80	90	SBR/NBR
K/S	200	350	-20	80	90	SBR
V/AT	175	350	-20	80	90	CR
PVG SBR	90	400	-10	50	60	SBR
PVG C1**	120	400	0	50	60	CR
PVG C2**	160	400	0	50	60	CR

- The development and production of the products is based on the relevant European standards
- All listed conveyor belts are available in belt widths of 500 - 2000 / 2400 mm

* DBP highly wear-resistant cover quality

** PVG conveyor belts correspond to the safety class according to EN-ISO 14973

* All information is given to the best of our knowledge. All specifications are to be considered non-binding information. Any claim for damages of any kind is excluded. We reserve the right to change technical specifications without prior notice, provided that they ensure product improvement. The information presented is based on technical experience but does not guarantee a product's suitability for specific applications, and does not relieve the users of the responsibility to undertake their own testing, including where any third-party trademark rights are concerned. For special applications and operating conditions with regard to temperature, UV light, ozone, acids and alkaline solutions, dynamic and static forces, tensions, elongations and other influences, we recommend application-technical consultation.

● COLD SPLICING AND REPAIR MATERIAL



REMA TIP TOP

Cold splicing and repair products

204-210

COLD SPLICING AND REPAIR MATERIAL

Cold splicing and repair products

Cold splicing and repair products

Filler rubber

With CN bonding layer on both sides.

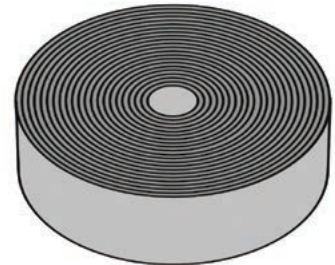

Filler rubber

Specifications

Polymer basis	SBR	DIN ISO 1629
Specific weight	1.12 g/cm ³	DIN EN ISO 1183-1
Hardness	62 Shore A	DIN ISO 7619-1
Colour	Black	

Ref. No.	Designation	Dimensions
528 5208	Filler rubber	0.5 x 500 x 10 000 mm
528 5198	Filler rubber	1.5 x 500 x 10 000 mm
528 5497	Filler rubber	3 x 500 x 10 000 mm

Filler rubber V

Self-extinguishing, antistatic and moderate oil resistance.

With CN bonding layer on both sides.

German underground approval: LOBA NW No.: 18.43.21-63-6

Ref. No.	Designation	Dimensions
528 5693	Filler rubber V	1.5 x 500 x 10 000 mm
528 5758	Filler rubber V	3 x 500 x 10 000 mm

COLD SPLICING AND REPAIR MATERIAL

Cold splicing and repair products

Cover strip

For cold splices on carrying and pulley side.

Specifications

Polymer basis	SBR	DIN ISO 1629
Specific weight	1.14 g/cm ³	DIN EN ISO 1183-1
Hardness	65 Shore A	DIN ISO 7619-1
Colour	Black	

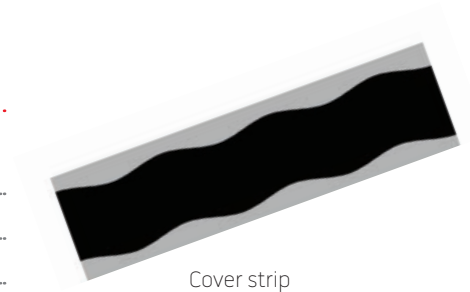

Cover strip

Ref. No.	Designation	Dimensions
531 6800	Cover strip	1.5x100x10 000 mm
532 8024	Cover strip V German underground approval: LOBA NW No.: 18.43.21-63-6	1.5x100x10 000 mm

Repair fabric EP 100

With CN bonding layer on both sides.

Ref. No.	Designation	Dimensions
522 0751	Repair fabric EP 100	1.8x500x10 000 mm



Repair fabric EP 100

COLD SPLICING AND REPAIR MATERIAL

Cold splicing and repair products

Rubber sheeting

With CN bonding layer on one side for the repair of damaged belt covers.

Specifications

Polymer basis	BR/IR/SBR	DIN ISO 1629
Specific weight	1.11 g/cm ³	DIN EN ISO 1183-1
Hardness	60 Shore A	DIN ISO 7619-1
Colour	Black	

Ref. No.	Designation	Dimensions
522 0218	Rubber sheeting	1.5 x 500 x 10 000 mm
522 0225	Rubber sheeting	2 x 500 x 10 000 mm
522 0232	Rubber sheeting	3 x 500 x 10 000 mm
522 0249	Rubber sheeting	4 x 500 x 10 000 mm
522 0256	Rubber sheeting	5 x 500 x 10 000 mm

Rubber sheeting V

Self-extinguishing, antistatic and moderate oil resistance.

With CN bonding layer on both sides.

German underground approval: LOBA NW No.: 18.43.21-63-6

Specifications

Polymer basis	CR	DIN ISO 1629
Specific weight	1.39 g/cm ³	DIN EN ISO 1183-1
Hardness	60 Shore A	DIN ISO 7619-1
Colour	Black	

Ref. No.	Designation	Dimensions
522 1815	Rubber sheeting V	1.5 x 500 x 10 000 mm
522 1839	Rubber sheeting V	3 x 500 x 10 000 mm
522 1853	Rubber sheeting V	5 x 500 x 10 000 mm

COLD SPLICING AND REPAIR MATERIAL

Cold splicing and repair products

Round patches

For the repair of small damaged areas in belt covers.

Specifications

Polymer basis	SBR	DIN ISO 1629
Specific weight	1.14 g/cm	DIN EN ISO 1183-1
Hardness	64 Shore A	DIN ISO 7619-1
Colour	Black	



Round patch

Ref. No.	Designation	Dimensions	Qty
530 7052	Round patch, Size 0	Ø 50 x 2 mm	10
530 7083	Round patch, Size 1	Ø 80 x 2.5 mm	10
530 7124	Round patch, Size 3	Ø 120 x 3.3 mm	10

Rhomboid patches

For the repair of large damaged areas in belt covers.

Ref. No.	Designation	Dimensions	Qty
530 7519	Rhomboid patch, Size 1	2.4 x 130 x 160 mm	5
530 7526	Rhomboid patch, Size 2	2.4 x 130 x 160 mm	5
530 7533	Rhomboid patch, Size 3	2.4 x 270 x 360 mm	5

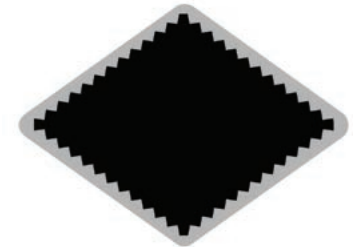

Rhomboid patch

Rhomboid patches EP 160, fabric reinforced

For the repair of perforations and ply damage.

Ref. No.	Designation	Dimensions	Qty
530 5511	Rhomboid patch EP 160, Size 1	3.8 x 130 x 160 mm	5
530 5528	Rhomboid patch EP 160, Size 2	3.8 x 200 x 260 mm	5
530 5535	Rhomboid patch EP 160, Size 3	3.8 x 270 x 360 mm	5

COLD SPLICING AND REPAIR MATERIAL

Cold splicing and repair products

Rectangular patches

For the repair of damaged belt covers.

Ref. No.	Designation	Dimensions	Qty
531 7066	Rectangular patch	1.5 x 50 x 1100 mm	30
531 7107	Rectangular patch	1.8 x 100 x 240 mm	10
531 7190	Rectangular patch	1.8 x 100 x 1100 mm	10
531 7293	Rectangular patch	2.8 x 150 x 1100 mm	10
531 7334	Rectangular patch	2.8 x 220 x 320 mm	10
531 7396	Rectangular patch	2.8 x 220 x 1100 mm	10
531 7451	Rectangular patch	3.0 x 300 x 500 mm	10
531 7499	Rectangular patch	3.0 x 300 x 1100 mm	10
531 7547	Rectangular patch	3.0 x 400 x 1100 mm	10



Rectangular patch

Rectangular patches EP 160, fabric reinforced

For the repair of perforations and ply damage.

Ref. No.	Designation	Dimensions	Qty
531 5109	Rectangular patch EP 160	3.2 x 100 x 240 mm	10
531 5295	Rectangular patch EP 160	4.2 x 150 x 1100 mm	10
531 5336	Rectangular patch EP 160	4.2 x 220 x 320 mm	10
531 5398	Rectangular patch EP 160	4.2 x 220 x 1100 mm	10
531 5491	Rectangular patch EP 160	4.4 x 300 x 1100 mm	10
531 5549	Rectangular patch EP 160	4.4 x 400 x 1100 mm	10



Rectangular patch EP 160

COLD SPLICING AND REPAIR MATERIAL

Cold splicing and repair products

Repair strip

For the repair of longitudinal belt cover damage.

Specifications

Polymer basis	SBR	DIN ISO 1629
Specific weight	1.14 g/cm	DIN EN ISO 1183-1
Hardness	64 Shore A	DIN ISO 7619-1
Colour	Black	

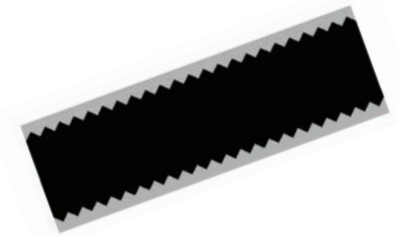

Repair strip

Ref. No.	Designation	Dimensions
531 7601	Repair strip	1.7x50x10 000 mm
531 7728	Repair strip	2.2x70x10 000 mm
531 7735	Repair strip	2.2x100x10 000 mm
531 7742	Repair strip	3.2x150x10 000 mm
531 7754	Repair strip	3.2x220x10 000 mm
531 7610	Repair strip	3.4x300x10 000 mm
531 7611	Repair strip	3.4x400x10 000 mm

Repair strip V

Self-extinguishing, antistatic and moderate oil resistance. For the repair of longitudinal belt cover damage.

German underground approval: LOBA NW No.: 18.43.21-63-6

Specifications

Polymer basis	CR	DIN ISO 1629
Specific weight	1.39 g/cm ³	DIN EN ISO 1183-1
Hardness	60 Shore A	DIN ISO 7619-1
Colour	Black	



Repair strip V

Ref. No.	Designation	Dimensions
531 8735	Repair strip V	2.2x100x10 000 mm
531 8742	Repair strip V	3.2x150x10 000 mm
531 8759	Repair strip V	3.2x220x10 000 mm

COLD SPLICING AND REPAIR MATERIAL

Cold splicing and repair products

Repair strip EP 160, fabric reinforced

For the repair of longitudinal tears in fabric ply and steel cord belts.

Specifications

Polymer basis	SBR	DIN ISO 1629
Specific weight	1.14 g/cm ³	DIN EN ISO 1183-1
Hardness	65 Shore A	DIN ISO 7619-1
Colour	Black	



Repair strip EP 160

Ref. No.	Designation	Dimensions
531 5737	Repair strip EP 160	3.6x100x10 000 mm
531 5744	Repair strip EP 160	4.6x150x10 000 mm
531 5751	Repair strip EP 160	4.6x220x10 000 mm
531 7620	Repair strip EP 160	4.8x300x10 000 mm
531 7621	Repair strip EP 160	4.8x400x10 000 mm

Repair strip EP 160 V, fabric reinforced

Self-extinguishing, antistatic and moderate oil resistance. For the repair of longitudinal tears in fabric ply and steel cord belts.

German underground approval: LOBA NW No.: 18.43.21-63-6

Ref. No.	Designation	Dimensions
531 6751	Repair strip EP 160 V	4x220x10 000 mm
531 6737	Reparaturband EP 160 V	3x100x10 000 mm

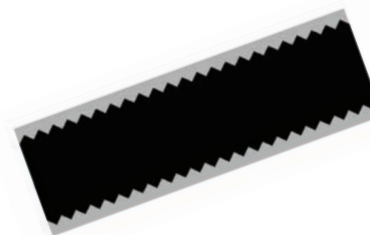

Repair strip EP 160 V

HOT SPLICING AND REPAIR MATERIAL



REMA TIP TOP



Hot splicing and repair products

212-219

HOT SPLICING AND REPAIR MATERIAL

Hot splicing and repair products

Hot splicing and repair products for conveyor belts with fabric plies

Cover rubber, uncured

Green protection foil (poly).

Specifications

Polymer basis	IR/BR	DIN ISO 1629
Specific weight	1.12 g/cm ³	DIN EN ISO 1183-1
Hardness	64 Shore A	DIN ISO 7619-1
Electric resistance	Antistatic*	
Colour	Black	

Ref. No.	Designation	Dimensions
538 0062	Cover rubber, uncured	1x500x17800 mm
538 0000	Cover rubber, uncured	2x500x9000 mm
538 0017	Cover rubber, uncured	3x500x6000 mm
538 0024	Cover rubber, uncured	4x500x4500 mm
538 0031	Cover rubber, uncured	5x500x3300 mm
538 0048	Cover rubber, uncured	6x500x2800 mm

* Surface and volume resistivity <math> < 1 \times 10^6 </math> Ohm, tested in accordance with DIN EN ISO 284, DIN IEC 93

HOT SPLICING AND REPAIR MATERIAL

Hot splicing and repair products

Cover rubber V, uncured

Gray protection foil (poly).
 Self-extinguishing, antistatic and moderate oil resistance.
 German underground approval: LOBA NW No.: 18.43.21-63-7.

Specifications

Polymer basis	CR	DIN ISO 1629
Specific weight	1.39 g/cm ³	DIN EN ISO 1183-1
Hardness	60 Shore A	DIN ISO 7619-1
Electric resistance	Antistatic*	
Colour	Black	

Ref. No.	Designation	Dimensions
538 0158	Cover rubber V, uncured	2 x 500 x 7000 mm

Cover rubber HR, uncured

Yellow protection foil (poly).
 Heat resistant up to max. 110 °C, short peaks up to 130 °C.

Specifications

Polymer basis	BR/IR	DIN ISO 1629
Specific weight	1.11 g/cm ³	DIN EN ISO 1183-1
Hardness	60 Shore A	DIN ISO 7619-1
Colour	Black	

Ref. No.	Designation	Dimensions
538 0206	Cover rubber HR, uncured	2 x 500 x 9200 mm
538 0196	Cover rubber HR, uncured	3 x 500 x 6000 mm

* Surface and volume resistivity <math> < 1 \times 10^6 \text{ Ohm}</math>, tested in accordance with DIN EN ISO 284, DIN IEC 93

HOT SPLICING AND REPAIR MATERIAL

Hot splicing and repair products

Intermediate rubber (tie gum), uncured

Ref. No.	Designation	Dimensions
538 0316	Intermediate rubber (tie gum), for Standard, K and HR-quality White protection foil.	0.8x500x10 300 mm
538 0189	Intermediate rubber (tie gum) V Green protection foil (poly). German underground approval: LOBA NW No.: 18.43.21-63-7	0.8x500x9000 mm

Repair fabric

Rubberized on both sides, uncured.
Green protection foil (poly).

Ref. No.	Designation	Dimensions	Content
538 0361	Perlon-Dreher fabric No. 10	0.9x920x10 000 mm	10 m roll
538 0354	Repair fabric EP 160	1.4x1000x10 000 mm	10 m roll

SOLUTION HL-T4

CHC-free

For Standard, K and HR quality cover rubber.

Ref. No.	Designation	Content	Qty
538 1377	SOLUTION HL-T4	500 g (670 ml)	10
538 1676	SOLUTION HL-T4	3.5 kg (4.7 l)	1
538 1683	SOLUTION HL-T4	7 kg (9.3 l)	1



538 1377

HOT SPLICING AND REPAIR MATERIAL

Hot splicing and repair products

SOLUTION HCR-4

CHC-free

Processed with 4 % HARDENER ER-42 or HARDENER E-40 (30 g per 1 kg).
For V-quality cover rubber.



525 1067

Ref. No.	Designation	Content	Qty
538 1646	SOLUTION HCR-4	700 g (730 ml)	10
525 1151	HARDENER ER-42	30 g	10
525 1067	HARDENER E-40	30 g	10

Accessories – Conveyor belts with fabric plies

Ref. No.	Designation	Dimensions	Content
538 0990	Shirting, black	1000 mm	per m
538 1009	Pressure compensation cloth, Rayon	1250 mm	per m
527 0550	Silicone paper	80 mm	25 m



538 0990



538 1009

HOT SPLICING AND REPAIR MATERIAL

Hot splicing and repair products

Hot splicing and repair products for steel cord conveyor belts

Cover rubber sheeting STB, uncured

Green protection foil.
Other thicknesses on request.

Specifications

Polymer basis	NR/IR/BR	DIN ISO 1629
Specific weight	1.14 g/cm ³	DIN EN ISO 1183-1
Hardness	63 Shore A	DIN ISO 7619-1
Colour	Black	

Ref. No.	Designation	Dimensions
538 0055	Cover rubber sheeting STB, uncured	1x500x17800 mm
538 0505	Cover rubber sheeting STB, uncured	2x500x9000 mm
538 0464	Cover rubber sheeting STB, uncured	3x500x6000 mm
538 5691	Cover rubber sheeting STB, uncured	3x1400x23000 mm
538 0471	Cover rubber sheeting STB, uncured	4x500x4500 mm
538 6341	Cover rubber sheeting STB, uncured	4x1400x23000 mm
538 0488	Cover rubber sheeting STB, uncured	5x500x3300 mm
538 5138	Cover rubber sheeting STB, uncured	5x1400x23000 mm
538 0495	Cover rubber sheeting STB, uncured	6x500x2800 mm
538 5031	Cover rubber sheeting STB, uncured	6x1400x23000 mm
538 5556	Cover rubber sheeting STB, uncured	12x1400x11500 mm
538 5580	Cover rubber sheeting STB, uncured	15x1400x11500 mm

HOT SPLICING AND REPAIR MATERIAL

Hot splicing and repair products

Intermediate rubber STZ, uncured

Red protection foil (poly).

Specifications

Polymer basis	NR/BR/SBR	DIN ISO 1629
Specific weight	1.21 g/cm ³	DIN EN ISO 1183-1
Hardness	66 Shore A	DIN ISO 7619-1
Colour	Black	



Ref. No.	Designation	Dimensions
538 0921	Intermediate rubber STZ, uncured	0.5 x 500 x 33 000 mm
538 0897	Intermediate rubber STZ, uncured	1 x 500 x 16 400 mm
538 0907	Intermediate rubber STZ, uncured	2 x 500 x 8200 mm
538 5519	Intermediate rubber STZ, uncured	2 x 1400 x 23 000 mm

Intermediate rubber strips STZ, uncured

Red protection foil (poly).

Specifications

Polymer basis	NR/BR/SBR	DIN ISO 1629
Specific weight	1.21 g/cm ³	DIN EN ISO 1183-1
Hardness	66 Shore A	DIN ISO 7619-1
Colour	Black	

Ref. No.	Designation	Dimensions	Content
544 0050	Intermediate rubber strips STZ, uncured	2 x 5 x 8200 mm	19 rolls
544 0060	Intermediate rubber strips STZ, uncured	2.5 x 5 x 6800 mm	19 rolls
544 0150	Intermediate rubber strips STZ, uncured	2 x 6 x 8200 mm	17 rolls
544 0160	Intermediate rubber strips STZ, uncured	2.5 x 6 x 6800 mm	17 rolls
544 0200	Intermediate rubber strips STZ, uncured	2 x 7 x 8200 mm	14 rolls
544 0270	Intermediate rubber strips STZ, uncured	2 x 8 x 8200 mm	12 rolls
544 0280	Intermediate rubber strips STZ, uncured	2.5 x 8 x 6800 mm	12 rolls

HOT SPLICING AND REPAIR MATERIAL

Hot splicing and repair products

Ref. No.	Designation	Dimensions	Content
544 0350	Intermediate rubber strips STZ, uncured	2x9x8200 mm	11 rolls
544 0360	Intermediate rubber strips STZ, uncured	2.5x9x6800 mm	11 rolls
544 0370	Intermediate rubber strips STZ, uncured	3x9x6800 mm	11 rolls
544 0430	Intermediate rubber strips STZ, uncured	2x10x8200 mm	10 rolls
544 0440	Intermediate rubber strips STZ, uncured	2.5x10x6800 mm	10 rolls
544 0510	Intermediate rubber strips STZ, uncured	2x11x8200 mm	9 rolls
544 0520	Intermediate rubber strips STZ, uncured	2.5x11x6800 mm	9 rolls
544 0600	Intermediate rubber strips STZ, uncured	2x12x8200 mm	8 rolls
544 0610	Intermediate rubber strips STZ, uncured	2.5x12x6800 mm	8 rolls
544 0620	Intermediate rubber strips STZ, uncured	3x12x6800 mm	8 rolls
544 0680	Intermediate rubber strips STZ, uncured	2x13x8200 mm	8 rolls
544 0690	Intermediate rubber strips STZ, uncured	2.5x13x6800 mm	8 rolls

STZ extruder

For correct and quick filling of a steel cord splice.

Ref. No.	Designation	Dimensions	Content
544 0900	STZ filling strips	4x20 mm	2 kg

SOLUTION STL-RF4

CHC-free

Ref. No.	Designation	Content	Qty
538 1256	SOLUTION STL-RF4	500 g (670 ml)	10
538 1281	SOLUTION STL-RF4	2 kg (2.67 l)	1
538 1274	SOLUTION STL-RF4	3.5 kg (4.67 l)	1
538 1267	SOLUTION STL-RF4	7 kg (9.3 l)	1



538 1267

HOT SPLICING AND REPAIR MATERIAL

Hot splicing and repair products

Accessories – Steel cord belts

Ref. No.	Designation	Dimensions	Content
538 0990	Shirting, black	1000 mm	per m
538 1009	Pressure compensation cloth, Rayon	1250 mm	per m
538 1092	Silicone paper	600 mm	500 m roll
538 1085	Silicone paper	900 mm	500 m roll
538 1078	Silicone paper	1200 mm	500 m roll
538 1061	Silicone paper	1300 mm	500 m roll
538 1054	Silicone paper	1500 mm	500 m roll
538 1023	Silicone paper	2180 mm	500 m roll



538 0990



538 1009

● WK SPLICING AND REPAIR MATERIAL



REMA TIP TOP



WK splicing and repair material

222-223

WK SPLICING AND REPAIR MATERIAL

WK splicing and repair material

WK splicing and repair material

The unique WK VULCANIZING SYSTEM combines the benefits of general hot splicing systems whilst considerably reducing vulcanizing time. Compared to traditional hot vulcanizing presses, the WK vulcanizing press is smaller, lighter and consumes less energy. The WK VULCANIZING SYSTEM is the ideal solution when it comes to safe and cost-efficient splicing of fabric-reinforced conveyor belts with low and medium tensile strengths.

Properties

- Belt-friendly, low-temperature vulcanization (approx. 120 °C / 230 °F)
- Short warm-up intervals
- Short vulcanization periods
- Short cooling time
- Low energy consumption
- Consists of only 4 components: Top / bottom press body, pressure compensation pad, torque wrench
- Suitable for splicing geometries of 0°/ 16°/ 22°

Area of application

- Splicing of single or multi-ply conveyor belts with fabric plies up to belt type EP 1250/5 (DIN 22102) and rubber covers with polymer base:
- Natural Rubber NR
- Styrene Butadiene Rubber SBR
- Isoprene Rubber IR
- Butadiene Rubber BR
- Or other blends of the above rubbers, e.g. NR/SBR
- Belt widths: WK 800 for belt widths up to 800 mm; WK 1200 for belt widths up to 1200 mm

WK intermediate rubber (tie gum)

Red protection foil (poly).

Specifications

Polymer basis	NR/SBR	DIN ISO 1629
Specific weight	1.08 g/cm ³	DIN EN ISO 1183-1
Hardness	59 Shore A	DIN ISO 7619-1
Colour	Black	

Ref. No.	Designation	Dimensions
527 0529	WK intermediate rubber (tie gum)	0.8 x 500 x 10 000 mm

WK SPLICING AND REPAIR MATERIAL

WK splicing and repair material

WK cover rubber (cover stock)

Red protection foil (poly).

Specifications

Polymer basis	NR	DIN ISO 1629
Specific weight	1.11 g/cm ³	DIN EN ISO 1183-1
Hardness	63 Shore A	DIN ISO 7619-1
Colour	Black	

Ref. No.	Designation	Dimensions
527 0536	WK cover rubber (cover stock)	2x500x5000 mm

SOLUTION HL-WK4

CHC-free

Processed with 4 % HARDENER ER-42 or HARDENER E-40 (15 g per 350 g).

Ref. No.	Designation	Content	Qty
527 0608	SOLUTION HL-WK4	350 g (390 ml)	10
525 1116	HARDENER ER-42	15 g	10
525 1122	HARDENER E-40	15 g	10



527 0608



525 1122

● MECHANICAL SPLICING
AND REPAIR MATERIAL



REMA TIP TOP



REMACLIP – Mechanical belt splicing systems

226-236



MECHANICAL SPLICING AND REPAIR MATERIAL

REMACLIP – Mechanical belt splicing systems

REMACLIP TTN

REMACLIP TTN S / TTN AS is a mechanical belt splicing system used for EP conveyor belts with strengths of up to 1400 N/mm.

Properties

- The stainless steel plates and staples are also suitable for use with corrosive media
- The configuration of the staples and length of the plates is designed for both extreme static pull-out strength and optimal dynamic running characteristics
- TTN AS is equipped with an additional sealing strip that prevents the loss of any material through the joint during belt operation

- The splices are supplied in 200 mm strips and packed in cartons for standard belt widths of 1000 mm or 1200 mm
- For compatible connecting pins, see REMACLIP connecting pins

Area of application

- Mechanical splicing system for fabric conveyor belts used in
- Coal mining
 - Gravel pits and quarries
 - Cement plants and steel works

REMACLIP TTN 10 S

- Pulley diameter min. 250 mm
- Belt strength max. 1000 N/mm
- Belt thickness 7 - 11 mm

Ref. No.	Designation	Belt width
530 2129	REMACLIP TTN 10 S	1000 mm

REMACLIP TTN 12 S

- Pulley diameter min. 350 mm
- Belt strength max. 1400 N/mm
- Belt thickness 8 - 12 mm

Ref. No.	Designation	Belt width
530 2150	REMACLIP TTN 12 S	1200 mm

MECHANICAL SPLICING AND REPAIR MATERIAL

REMACLIP – Mechanical belt splicing systems

REMACLIP TTN 14 S

- Pulley diameter min. 350 mm
- Belt strength max. 1400 N/mm
- Belt thickness 10 - 14 mm

Ref. No.	Designation	Belt width
530 2174	REMACLIP TTN 14 S	1200 mm

REMACLIP TTN 16 S

- Pulley diameter min. 350 mm
- Belt strength max. 1400 N/mm
- Belt thickness 13 - 16 mm

Ref. No.	Designation	Belt width
530 2198	REMACLIP TTN 16 S	1200 mm

REMACLIP TTN 10 AS with seal

- Pulley diameter min. 250 mm
- Belt strength max. 1000 N/mm
- Belt thickness 7 - 11 mm

Ref. No.	Designation	Belt width
530 4213	REMACLIP TTN 10 AS	1200 mm

REMACLIP TTN 16 AS with seal

- Pulley diameter min. 350 mm
- Belt strength max. 1400 N/mm
- Belt thickness 13 - 16 mm

Ref. No.	Designation	Belt width
530 4268	REMACLIP TTN 16 AS	1000 mm

MECHANICAL SPLICING AND REPAIR MATERIAL

REMACLIP – Mechanical belt splicing systems

REMACLIP TTE

The REMA CLIP Ecosystem TTE is used for conveyor belts with strengths up to 1400 N/mm when the splice is to be replaced after a short running time.

Properties

- Plate material and staples are made from carbon steel
- Alignment of the staples and length of the plates have been optimised through extensive testing and designed for high static pull-out strength and for good dynamic running characteristics

- The splices are supplied in 200 mm strips and packed in cartons for standard belt widths of 1000 mm or 1200 mm

Area of application

Temporary splicing system for fabric conveyor belts used in

- Coal mining
- Gravel pits and quarries
- Cement plants and steel works

REMACLIP TTE 10

- Pulley diameter min. 250 mm
- Belt strength max. 1000 N/mm
- Belt thickness 7 - 11 mm

Ref. No.	Designation	Belt width
530 2222	REMACLIP TTE 10	1000 mm
530 2239	REMACLIP TTE 10	1200 mm

REMACLIP TTE 12

- Pulley diameter min. 350 mm
- Belt strength max. 1400 N/mm
- Belt thickness 8 - 12 mm

Ref. No.	Designation	Belt width
530 2246	REMACLIP TTE 12	1000 mm

MECHANICAL SPLICING AND REPAIR MATERIAL

REMACLIP – Mechanical belt splicing systems

Installation device for REMACLIP TTN and TTE

With the mechanical lacing machine TM, feeding and injection are performed manually. Screw clamps TS are available in the standard widths of 1200 and 1400 mm.

Mechanical lacing machine TM



Ref. No.	Designation
530 2590	Mechanical lacing machine TM

Screw clamps TS

Ref. No.	Designation
530 2617	Screw clamps TS 1 200
530 2624	Screw clamps TS 1 400

Wave stop system

The wave stop system TWS is suitable for belts of up to 1600 N/mm. Installation of the TTN and TTE systems leads to compression which may produce belt displacement, creating a bow or wave. By inserting the tensioning cable (= wave stop system) between the belt and the mechanical splice, formation of waves and bows is prevented and insertion of the connection pins is facilitated. In addition, the belt runs evenly over belt scrapers, wear is minimized and excessive stress on the belt edge is avoided.

Ref. No.	Designation	Length	Qty
530 3654	TWS kit TWS kit (in metal case) consists of: Tension unit, 2 clamps, 20 tension cables with locking plate (2600 mm), cutting pliers and spacer.		
530 3661	TWS mounting kit TWS mounting set (packing unit: 10 pcs each) consisting of: clamp, tension screw holder, M6 tension screw, and M6 VZ wing nut		
530 3678	TWS tension cable with locking plate	1800 mm	20
530 3685	TWS tension cable with locking plate	2600 mm	20



530 3654



530 3678

MECHANICAL SPLICING AND REPAIR MATERIAL

REMACLIP – Mechanical belt splicing systems

Belt plane device

Planing is recommended for cover rubber thicknesses over 2 mm. The planer allows accurate planing of rubber covers with minimal effort. Planing provides a proven advantage: the belt fasteners are recessed in the belt cover, thereby reducing or avoiding the risk of damage to belt fasteners, scrapers, rollers, drive pulleys or tail pulleys.

Ref. No.	Designation
530 4639	Belt plane device for frames TS, TTN + TTE system (5 - 20 mm)
530 4646	Spare blade, for belt plane devices



530 4639



530 4646

REMACLIP TTB

The REMACLIP TTB bolt system is used as a temporary splice and for repair.

Area of application

- TTB splices made from steel, for general use
- TTB H wear-resistant fasteners with high-carbon steel top plate for use with highly abrasive materials



REMACLIP TTB 1

- Pulley diameter min. 250 mm
- Belt strength max. 300 N/mm
- Belt thickness 5 - 11 mm

Ref. No.	Designation	Belt width	Qty
530 2404	REMACLIP TTB 1	1000 mm	25
530 2411	REMACLIP TTB 1 H	1000 mm	25

MECHANICAL SPLICING AND REPAIR MATERIAL

REMACLIP – Mechanical belt splicing systems

REMACLIP TTB 140

- Pulley diameter min. 300 mm
- Belt strength max. 400 N/mm
- Belt thickness 5 - 11 mm

Ref. No.	Designation	Belt width	Qty
530 2435	REMACLIP TTB 140	1000 mm	25
530 2442	REMACLIP TTB 140 H	1000 mm	25

REMACLIP TTB 190

- Pulley diameter min. 400 mm
- Belt strength max. 600 N/mm
- Belt thickness 8 - 14 mm

Ref. No.	Designation	Belt width	Qty
530 2466	REMACLIP TTB 190	1000 mm	25
530 2473	REMACLIP TTB 190 H	1000 mm	25

REMACLIP TTB 1 ½

- Pulley diameter min. 400 mm
- Belt strength max. 500 N/mm
- Belt thickness 11 - 17 mm

Ref. No.	Designation	Belt width	Qty
530 2507	REMACLIP TTB 1 ½	1000 mm	25
530 2514	REMACLIP TTB 1 ½ H	1000 mm	25

MECHANICAL SPLICING AND REPAIR MATERIAL

REMACLIP – Mechanical belt splicing systems

REMACLIP TTB 2

- Pulley diameter min. 700 mm
- Belt strength max. 750 N/mm
- Belt thickness 14 - 21 mm

Ref. No.	Designation	Belt width	Qty
530 2545	REMACLIP TTB 2	1000 mm	25
530 2552	REMACLIP TTB 2 H	1000 mm	25

REMACLIP TTB 2 ½

- Pulley diameter min. 1000 mm
- Belt strength max. 750 N/mm
- Belt thickness 19 - 25 mm

Ref. No.	Designation	Belt width	Qty
530 2583	REMACLIP TTB 2 ½	1000 mm	10

REMACLIP TTB 2 ¾

- Pulley diameter min. 1000 mm
- Belt strength max. 850 N/mm
- Belt thickness 14 - 30 mm

Ref. No.	Designation	Belt width	Qty
530 3874	REMACLIP TTB 2 ¾	1000 mm	25

Installation accessories for REMACLIP TTB

Template TL-B

The template ensures that the holes for the bolt fasteners are punched in exactly the right position. It is available in the standard length of 1050 mm and suitable for the various sizes of fasteners.

Ref. No.	Designation
530 2727	Template TL-B 140
530 2734	Template TL-B 190
530 2758	Template TL-B 1.5
530 2765	Template TL-B 2



Punch

For punching holes for the bolt fasteners. Punched-out material is automatically ejected during repeated punching.

Ref. No.	Designation
530 2789	Punch TS-B 1-140-19
530 2796	Punch TS-B 1.5 -2-2.25
530 2806	Punch TS-B 2.5



Wrench

The wrench is used where height is restricted. It is designed to safely tighten the nuts.

Ref. No.	Designation
530 2813	Wrench, TH-B 1-140-190
530 2820	Wrench TH-B 1.5-2-2.25
530 2837	Wrench TH-B 2.5



MECHANICAL SPLICING AND REPAIR MATERIAL

REMA CLIP – Mechanical belt splicing systems

Socket wrench

The socket wrench is designed to safely tighten the nuts.



Ref. No.	Designation
530 2844	Socket wrench TA-B 1-140-190
530 2851	Socket wrench TA-B 1.5-2-2.25
530 2868	Socket wrench TA-B 2.5

Bolt breaker

The bolt breakers are used to break off protruding screw ends. They are used in pairs for safe and convenient handling.



Ref. No.	Designation
530 2875	Bolt breaker 1-140-190
530 2882	Bolt breaker 1.5-2-2.25
530 2899	Bolt breaker 2.5

MECHANICAL SPLICING AND REPAIR MATERIAL

REMACLIP – Mechanical belt splicing systems

REMACLIP shark tooth clips

Shark tooth clips TT-R are primarily used for quick repair of small tears and cuts in conveyor belts or as an aid for retracting or changing belts.

Shark tooth clips TT-R

Ref. No.	Designation	Qty
530 4024	Shark tooth clips TT-R-8	100
530 4031	Shark tooth clips TT-R-10	100
530 4048	Shark tooth clips TT-R-13	100
530 4055	Shark tooth clips TT-R-15	100
530 4062	Shark tooth clips TT-R-18	100
530 4079	Shark tooth clips TT-R-21	100



REMACLIP connecting pins

Connecting pins, which are employed as splicing rods, are used for the REMACLIP TTN / TTE / TTM Systems.

Connecting pin TT10 S

- Sheathed stainless steel wire pin
- Sheath: chrome steel
- Min. diameter 5.3 mm

Ref. No.	Designation
530 3166	Connecting pin TT10 S Belt width 800



Connecting pin TT10 SG

- Sheathed stainless steel wire pin
- Sheath: chrome steel with thread
- Min. diameter 5.3 mm

Ref. No.	Designation
530 3290	Connecting pin TT10 SG Belt width 1 000



MECHANICAL SPLICING AND REPAIR MATERIAL

REMACLIP – Mechanical belt splicing systems

Connecting pin TT12 S

- Sheathed stainless steel wire pin
- Sheath: chrome steel
- Min. diameter 6.4 mm



Ref. No.	Designation
530 3221	Connecting pin TT12 S Belt width 1 200

Connecting pin TT16 S

- Sheathed stainless steel wire pin
- Sheath: chrome steel
- Min. diameter 7.1 mm



Ref. No.	Designation
530 3252	Connecting pin TT16 S Belt width 1 000
530 3269	Connecting pin TT16 S Belt width 1 200
530 3276	Connecting pin TT16 S Belt width 1 400

REMACLIP accessories

Hand wrench THS

Hand wrench for screwing in TT SG connecting pins.



530 2909

Ref. No.	Designation
530 2909	Hand wrench THS

Hammer pin driver



530 4660

Ref. No.	Designation
530 4660	Hammer pin driver for connecting pins

QUESTIONNAIRE

REMAMILL lining

Customer:	Contact person:
Phone:	Fax:
Address:	Country (representation):
	E-Mail:

Mill Data

Manufacturer:	Mill Serial No.:
Installed Engine Power: KW	Delivery year:

Conditions of operation

Grinding Stage	<input type="checkbox"/> Primary	<input type="checkbox"/> Secondary	<input type="checkbox"/> Regrind
Type of Mill*	<input type="checkbox"/> Autogeneous (AG) <input type="checkbox"/> Ball <input type="checkbox"/> Multi compartment	<input type="checkbox"/> Semiautogeneous (SAG) <input type="checkbox"/> Pebble <input type="checkbox"/> Batch (additional questionnaire)	<input type="checkbox"/> Rod <input type="checkbox"/> Washing drum
Process*	<input type="checkbox"/> Overflow <input type="checkbox"/> Center peripheral	<input type="checkbox"/> Grate <input type="checkbox"/> Other	<input type="checkbox"/> End peripheral
Process*	<input type="checkbox"/> Wet	<input type="checkbox"/> Dry, max. temperature	°C
Inside diameter* mm	Length (inside) mm		
Inner diameter of the feed trunnion* mm			
Inner diameter of the discharge trunnion* mm			
Heads*	<input type="checkbox"/> Straight	<input type="checkbox"/> Inclined	<input type="checkbox"/> Cupped
Speed*	<input type="checkbox"/> Fixed <input type="checkbox"/> Variable, between	rpm or equal to	% Ncr and rpm
Rotating direction,	seen from feed end: <input type="checkbox"/> Clockwise	<input type="checkbox"/> Anticlockwise	<input type="checkbox"/> Dual
Number of manholes*:			
Numbers of rows*:	Feed end head	Shell	Discharge end head
Grinding media	Type*:	Max. size: mm	Charge volume media: %

Operational data

Type of ground material*:	Max. size of feed*:	mm	
Capacity*:	Product size*:	µm	
Type of water used*	<input type="checkbox"/> Well water	<input type="checkbox"/> Recycled water	<input type="checkbox"/> Other
Oil or chemicals in process water*:	<input type="checkbox"/> Yes	<input type="checkbox"/> No	
pH value of process water*:	Conductivity	µS cm ⁻¹	
Operating: hours / year	Bond work index:	kWh/t	

Existing lining product

Manufacturer:	<input type="checkbox"/> Steel	<input type="checkbox"/> Rubber	<input type="checkbox"/> Other
Thickness of lining: (rubber lining)	Feed end head plate: mm	Lifter: mm	
	Shell plate: mm	Lifter: mm	
	Discharge end head plate: mm	Lifter: mm	

*minimum data required for a preliminary quotation

Place and date	Name	Signature
----------------	------	-----------

QUESTIONNAIRE

Wear protection lining

Customer:	Contact person:
Phone:	Fax:
Address:	Country (representation):
	E-Mail:

1) Equipment

Equipment or installation to be lined:	
<input type="checkbox"/> Partial lining	<input type="checkbox"/> Equipment already in operation
<input type="checkbox"/> Complete lining	<input type="checkbox"/> No. of drawing _____ / drawing enclosed
<input type="checkbox"/> New lining	<input type="checkbox"/> Still in planning stage
<input type="checkbox"/> Previously lined	<input type="checkbox"/> Indicate angle in drawing
Manufacturer:	Remarks:
Material:	
Thickness of material:	
Fixing system:	
Total material flow:	

2) Purpose of the lining

<input type="checkbox"/> Protection from wear	<input type="checkbox"/> Noise reduction
<input type="checkbox"/> Protection from corrosion	<input type="checkbox"/> Other:
<input type="checkbox"/> Protection from caking	

3) Information about transported materials

Type of material:	Lump size
Composition of material:	From: _____ To: _____
	Breakdown of lump size in percentage:
Spec. weight:	
Humidity:	
Oil content:	
Chemicals (especially acids):	
Constant temperature:	Maximum temperature:
	Period:

QUESTIONNAIRE
Wear protection lining

4) Material delivery (feeding system)

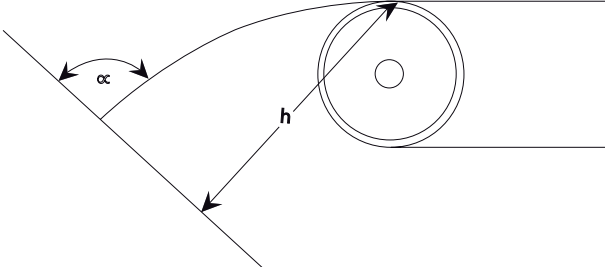
<input type="checkbox"/> Conveyor belt	Belt speed: _____ m/s
<input type="checkbox"/> Truck	Tonnage/load: _____
<input type="checkbox"/> Excavator	
<input type="checkbox"/> Other method:	
<input type="checkbox"/> Capacity/h	
<input type="checkbox"/> Angle of impact (see sketch)	
<input type="checkbox"/> Height of fall h (see sketch)	
Area of impact marked in drawing no. _____	
Type of wear (abrasive or cutting, etc.) and any further information: _____	

5) Recommended type of lining (to be filled out by REMA TIP TOP)

Material: _____	Fixing system: _____
Dimensions: _____	
Modification of existing construction: _____	<input type="checkbox"/> Not necessary <input type="checkbox"/> Not possible <input type="checkbox"/> Required (drawing enclosed!)
Problems during installation: _____	
Additional information: _____	

Place and date _____ Name _____ Signature _____

QUESTIONNAIRE

Pulley lagging

Customer:	Contact person:
Phone:	Fax:
Address:	Country (representation):
	E-Mail:

General information on conveyor system

Manufacturer/OEM:					
Maintained by:					
Type of plant:					
Year built:					
Location	<input type="checkbox"/> Outside	<input type="checkbox"/> Roofed over	<input type="checkbox"/> Closed room	<input type="checkbox"/> Underground	
Temperature \emptyset	°C	Min.	°C	Max.	°C
	Carrying capacity		t/h		
Operating times	Day	h/d	Week	d/w	
Conveying direction	<input type="checkbox"/> horizontal	<input type="checkbox"/> rising	<input type="checkbox"/> falling		
Please attach pictures! If possible, attach a drawing of the plant!					

Information on drive / If more than three drive pulleys, please record in notes

Speed	v=	m/s					
	Drive power [kW]	Pulley \emptyset [mm]	Wrap angle [°]	T1 Start [kN]	T1 Running [kN]	T2 Start [kN]	T2 Running [kN]
Pulley 1:							
Pulley 2:							
Pulley 3:							
Drive on	<input type="checkbox"/> System head		<input type="checkbox"/> System foot		<input type="checkbox"/> Multiple		
Reversing operation	<input type="checkbox"/> Yes		<input type="checkbox"/> No				

Information on material being conveyed

Designation:				
Min. lump size	Max.	mm	Specific weight	g/cm ³
Moisture	%		Temperature	°C
Oil/grease or chemicals	<input type="checkbox"/> No		<input type="checkbox"/> If yes, which kind:	
Please attach pictures!				

Place and date	Name	Signature
----------------	------	-----------

QUESTIONNAIRE

Pulley lagging

Customer:	Contact person:
Phone:	Fax:
Address:	Country (representation):
	E-Mail:

Information about conveyor belt

Type	<input type="checkbox"/> Fabric belt	<input type="checkbox"/> Steel cord belt	<input type="checkbox"/> PVC/PVG
Manufacturer:	Designation:		
Strength:	Pretension kN		
Troughing transition	m	Belt trough °	
Dimensions	Width mm	Thickness mm	Length mm
Cover plate thickness	Running side mm	Conveying side mm	
Condition	<input type="checkbox"/> New	<input type="checkbox"/> Used	<input type="checkbox"/> Damaged
Splice type	<input type="checkbox"/> Cold	<input type="checkbox"/> Hot	<input type="checkbox"/> Mechanical

Information on pulley / If multiple drives, please record data in notes

Type of pulley	<input type="checkbox"/> Drive	<input type="checkbox"/> Bend pulley	<input type="checkbox"/> Snub pulley
Pulley width	B1 mm	B2 mm	B3 mm
Crown bow	<input type="checkbox"/> Yes	<input type="checkbox"/> Yes	<input type="checkbox"/> Yes

Old lagging

Manufacturer:	Type:			
Lagging thickness: mm	Service life:			
Problem:				
Required quality	<input type="checkbox"/> V	<input type="checkbox"/> S	<input type="checkbox"/> HR	<input type="checkbox"/> OIL
Please attach pictures!				

New lagging

Lagging thickness: mm	Type:		
Date installed:	Planned service life:		
Special quality	<input type="checkbox"/> V	<input type="checkbox"/> HR	<input type="checkbox"/> OIL
Please attach pictures!			

Notes, special details!

Place and date	Name	Signature
----------------	------	-----------

QUESTIONNAIRE
REMACLEAN belt cleaning systems

Customer:	Contact person:
Phone:	Fax:
Address:	Country (representation):
	E-Mail:

Information about conveyor equipment

Belt designation:	Type / brand:	Belt thickness (mm):
Belt width (mm):	Axial distances (m):	Belt speed (m/s):
Belt surface:	<input type="checkbox"/> New	<input type="checkbox"/> Used / smooth
	<input type="checkbox"/> Damaged	<input type="checkbox"/> Heavily damaged
Belt splice:	<input type="checkbox"/> Cold	<input type="checkbox"/> Hot
	<input type="checkbox"/> Mechanical/Type	
Pulley diameter (mm):	Pulley shape:	<input type="checkbox"/> Cylindric
		<input type="checkbox"/> Curved
Pulley Lagging <input type="checkbox"/> Yes <input type="checkbox"/> No:	Attachment	<input type="checkbox"/> Cold
		<input type="checkbox"/> Hot
Pulley lagging designation:	Reverse mode:	<input type="checkbox"/> Mechanical
		<input type="checkbox"/> Yes
Operating time:	hours per day:	hours per week
Temperature at the position of the belt cleaning system:	°C	
Remarks:		

Material conveyed

Moisture content:		%:	Tends to dry or harden	<input type="checkbox"/> Yes	<input type="checkbox"/> No
Quartz content:	<input type="checkbox"/> Yes,	%:	<input type="checkbox"/> No		
Sticky admixture content:					

Installed cleaning system

Manufacturer:	Type:
Assessment of the cleaning performance:	
Remarks:	

Information prepared by:

Place and date	Name	Signature
----------------	------	-----------

Recommendation for a new belt cleaning system

Type:	Ref. No.:
Remarks:	

Recommendation prepared by:

Place and date	Name	Signature
----------------	------	-----------

QUESTIONNAIRE
 REMACLEAN belt cleaning systems – dimensions

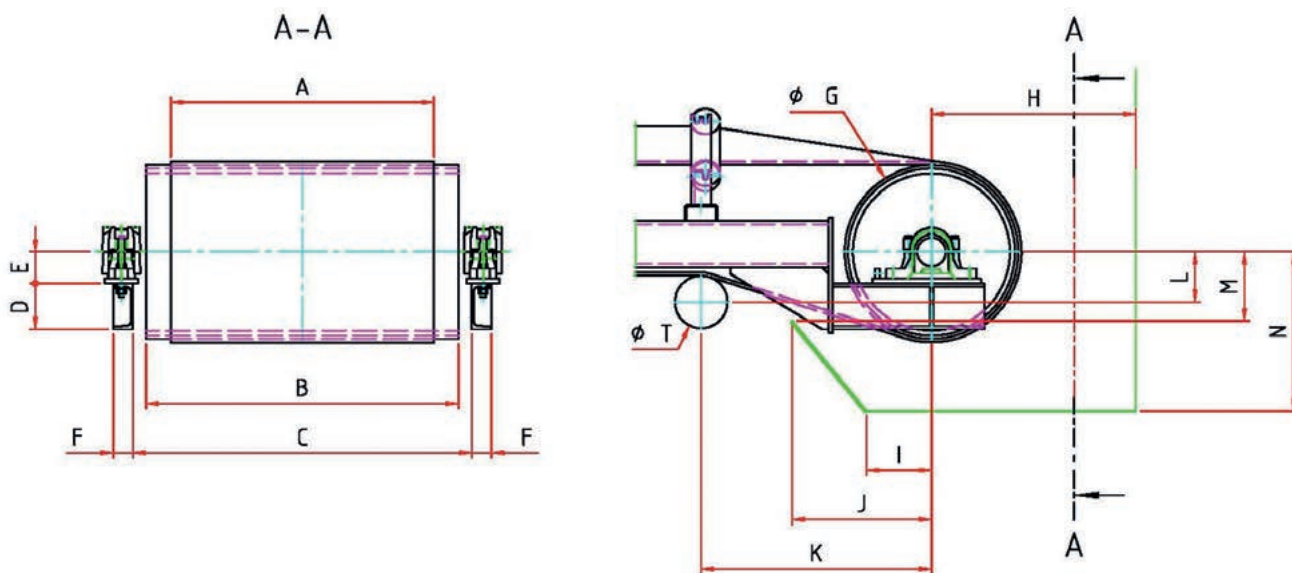

A		I	
B		J	
C		K	
D		L	
E		M	
F		N	
G		T	
H			

Remarks

QUESTIONNAIRE

Conveyor belt cover systems

Customer:	Contact person:
Phone:	Fax:
Address:	Country (representation):
	E-Mail:

Please enter all data and ask REMA TIP TOP for an individual offer!

ID	Designation	Value
A	Width of structure	mm
B	Distance between fitting drill holes	mm
D	Profile size	mm
E	Roll length	mm
G	Width roll to roll	mm
H	Roll diameter	mm
K	Distance profile to roll	mm
M	Distance profile to upper edge of roll	mm
Y	Ceiling distance	mm
Z	Cover plate	<input type="checkbox"/> Yes <input type="checkbox"/> No
P	Profile alignment	<input type="checkbox"/> Inwards <input type="checkbox"/> Outwards
L	No. of elements	per 1200 mm

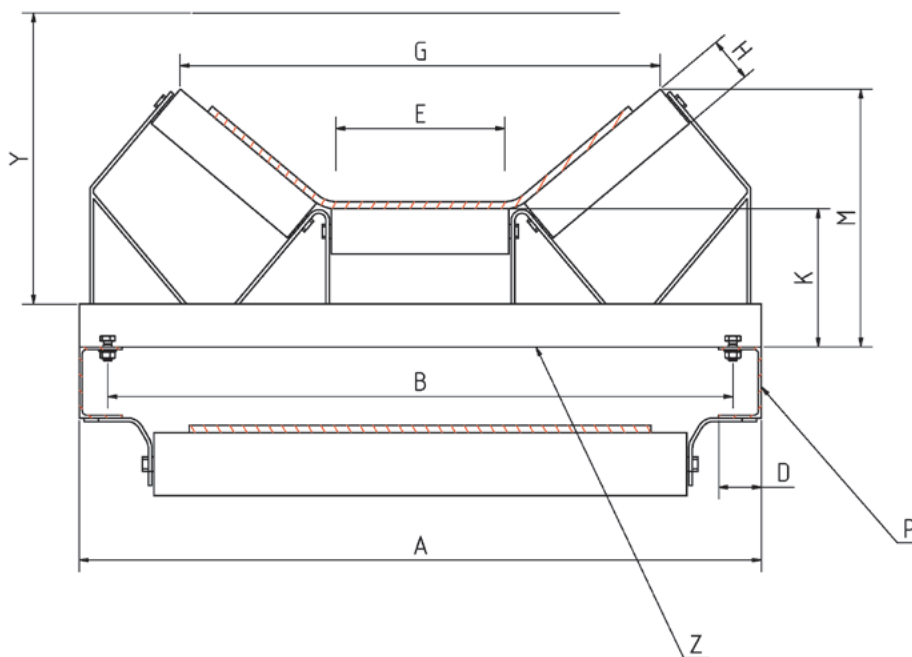

Place and date

Name

Signature

QUESTIONNAIRE

Splice packages for steel cord belts

Customer:	Contact person:
Phone:	Fax:
Address:	Country (representation):
	E-Mail:

We hereby request an offer for _____ units of splice packages, as per following specifications:

Belt manufacturer	
Belt specifications/Belt designation	St
Rubber grade	mm
Cable pitch	mm
Cable diameter	mm
Belt width	mm
Top cover thickness	mm
Bottom cover thickness	mm
Specified splice length	mm
Splice geometry	<input type="checkbox"/> Rhombic (16°) <input type="checkbox"/> Rectangular <input type="checkbox"/> Rhombic (22°) <input type="checkbox"/> Other:
Breaker	<input type="checkbox"/> Running side <input type="checkbox"/> Carrying side

Place and date

Name

Signature

QUESTIONNAIRE

Material handling hose systems

Customer:	Contact person:
Phone:	Fax:
Address:	Country (representation):
	E-Mail:

1) Process

<input type="checkbox"/> Hydraulic transport	<input type="checkbox"/> Pneumatic transport	<input type="checkbox"/> Transport by gravitation
Medium/material:		
Specific weight:	g/cm ³	
Chemicals:		
Concentration:	Temperature:	
Particle size of solid material:		
Flow rate:	m ³ /s	
Velocity:	m/s	

2) Material handling hose

Inner diameter:	mm	Length:	m
Qty elbows/bends (please attach piping diagram):			
Flange/coupling:	Type:	Material:	
Flange holes according to standard:			
Bolt circle:	mm		
Outer diameter:	mm		
Bolt holes:	mm		
Operating pressure:			
<input type="checkbox"/> Pressure	<input type="checkbox"/> Suction	<input type="checkbox"/> Pressure and suction	
Working pressure:	MPa	Vacuum:	MPa
Permanent temperature:	°C	Maximum temperature:	°C/ min
Minimal bending radius:	mm		

3) Customer preferences

Problems:

Additional information:

Drawing attached:

<input type="checkbox"/> Yes	<input type="checkbox"/> For retention	<input type="checkbox"/> For returning
------------------------------	--	--

Place and date Name Signature

QUESTIONNAIRE
 REMAROLL – Rollers

Customer:

Phone:

Address:

Contact person:

Fax:

Country (representation):

E-Mail:

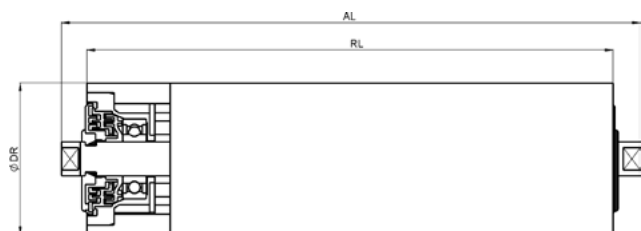

ID	Description	Value
DR	Roll diameter	mm
AL	Shaft length	mm
RL	Roll length	mm

Material of axis

Machining steel	<input type="checkbox"/>		
Stainless steel 1.4301 (V2A)	<input type="checkbox"/>		
Stainless steel 1.4401 (V4A)	<input type="checkbox"/>		
Stainless steel 1.4507	<input type="checkbox"/>		

Conditions of operation

Carrying capacity Q	m ³ /h		
Belt width BB	mm		
Belt type / brand:			
Belt speed			
Up to 2.5 m/s			
Up to 3.5 m/s			
Up to 5.5 m/s			
ATEX 21-environment	<input type="checkbox"/>		
Seawater resistant	<input type="checkbox"/>		

Additional information:

.....

.....

.....

.....

.....

.....

.....

.....

.....

.....

QUESTIONNAIRE
 REMAROLL – Rollers

Customer:

Contact person:

Phone:

Fax:

Address:

Country (representation):

E-Mail:

Axis with across flats

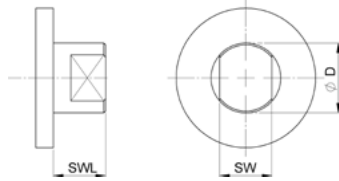

ID	Value	ID	Value
SWmm	Dmm
SWLmm		

Axis with tapping

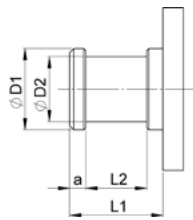

ID	Value	ID	Value
D1mm	L2mm
D2mm	amm
L1mm		

Axis with shaft

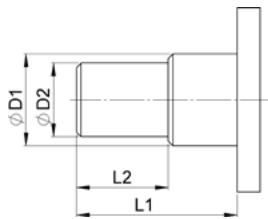

ID	Value	ID	Value
D1mm	L1mm
D2mm	L2mm

Axis with external thread

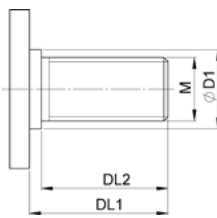

ID	Value	ID	Value
DL1mm	D1mm
DL2mm	Thread Mmm

Axis with internal thread

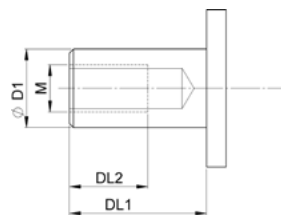

ID	Value	ID	Value
DL1mm	D1mm
DL2mm	Thread Mmm

Single axis

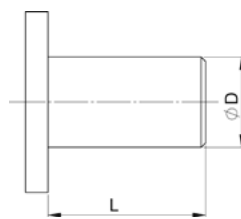

ID	Value	ID	Value
Dmm		
Lmm		

Place and date

Name

Signature

NATURAL AND SYNTHETIC RUBBER – TYPICAL CHARACTERISTICS

Abbreviation according to DIN ISO 1629	Designation	General Characteristics of Vulcanized Rubber	Operating Temperatures (°C)	
			longer periods	short periods
NR	Natural Rubber	Multi purpose rubber with the most balanced characteristics (high tensile strength, elasticity and resistance to wear). Moderate resistance against ozone (light colors only). Not resistant against oil, grease and fuel.	-30 to +80	-55 to +90
IR	Isoprene Rubber	see NR		
BR	Butadiene Rubber	Only used for blends with other elastomers (NR, IR, SBR). Very high abrasion-resistance and high elasticity.	-40 to +100	-60 to +110
CR	Chloroprene Rubber	High flame resistance, good resistance against chemicals, ozone and ageing. Moderate resistance against oil and grease.	-25 to +90	-30 to +110
SBR	Styrene Butadiene Rubber	High tensile strength and abrasion-resistance. Moderate to good resistance against ozone, ageing. Not resistant against oil and grease.	-25 to +90	-30 to +100
NBR	Nitrile Rubber	Special rubber with high resistance against mineral oil, grease and fuel. Moderate to good resistance against ozone and ageing (light colors only).	-25 to +100	-35 to +120
IIR	Butyl Rubber	Special rubber with low air permeability and excellent dampening properties. Good resistance against heat. Not resistant against oil, grease and fuel.	-30 to +120	-40 to +140
CIIR BIIR	Chlorbutyl / Brombutyl Rubber	Special rubber with high chemical resistance (acids, alkaline solutions). Good resistance against heat and ozone. High resistance against water vapors. Not resistant against oil, grease and fuel.	-40 to +100	-40 to +120
AU	Polyurethane	Very good abrasion-resistance. Good resistance against mineral oil, grease and fuel. High elasticity.	-30 to +80	-30 to +80
CSM	Chlorosulfonated Polyethylen	Excellent resistance against ozone and weathering. Good resistance against oxidizing chemicals (chromic acid, hypochlorite). Good resistance against mineral oil and fuel. Electrically insulating.	-20 to +100	-20 to +120

This is general information. In specific cases we recommend you to seek for technical application advice regarding stresses caused by temperature, ozone, media dynamic and static forces, tension, distension or any other influences. Instruction or operation manuals and product information have to be taken notice of.

INDEX

A

Accessories – Conveyor belts with fabric plies	215
Accessories – REMACLEAN HM-U1	154
Accessories – REMACLEAN HM-U2	157
Accessories – REMACLEAN HM-U7 / HM-U8 / HM-U11R / PUR-F5 / PUR-F5 VA	166
Accessories – REMASLEEVE VSB / KSB	120
Accessories – Steel cord belts	219

B

Belt plane device	230
Bolt breaker	234

C

CEMENT BC 3000	72
CEMENT BC 3004	61
CEMENT MC 2000	60
CEMENT PC-4	62
CEMENT SC 2000	71
CEMENT SC 4000	58
CN crowning wedge	95
Connecting pin TT10 S	235
Connecting pin TT10 SG	235
Connecting pin TT12 S	236
Connecting pin TT16 S	236
Corrugated rubber edge	197
Cover rubber HR, uncured	213
Cover rubber sheeting STB, uncured	216
Cover rubber, uncured	212
Cover rubber V, uncured	213
Cover strip	205
Cover strip CK-X / CP-X	95

D

DUNLOP HD slurry handling hoses	192
---------------------------------	------------

F

Filler rubber	204
Filler rubber V	204
FIXPASTE REMA GOO	68
FIXPASTE VC-4 set	67

G

Gaskets, for DUNLOP HD slurry handling hoses	194
--	------------

H

Hammer pin driver	236
Hand wrench THS	236
HDL and HDL MP drill	52
HDL and HDL MP Fastening Unit A	52
HDL and HDL MP Fastening Unit B	52
HDL MP plate	47
HDL plate	49

I

Intermediate rubber strips STZ, uncured	217
Intermediate rubber STZ, uncured	217
Intermediate rubber (tie gum), uncured	214

K

KG bars	41
---------	-----------

M

Measuring bucket	65
Measuring cup	65
Mechanical lacing machine TM	229
METAL PRIMER	63

INDEX

O

Outlet valve for drums **65**

P

Punch **233**

R

Rectangular patches **208**

Rectangular patches EP 160, fabric reinforced **208**

REMACLEAN 60 **122**

REMACLEAN 60 MOR **123**

REMACLEAN 70 **124**

REMACLEAN 70 V **125**

REMACLEAN C **133**

REMACLEAN CAB GREEN **126**

REMACLEAN CAB GREY **127**

REMACLEAN GRB **171**

REMACLEAN HM-F1 **140**

REMACLEAN HM-F2 **141**

REMACLEAN HM-F2 VA **143**

REMACLEAN HML **135**

REMACLEAN HM-U1 **153**

REMACLEAN HM-U1 HR **154**

REMACLEAN HM-U1 VA **155**

REMACLEAN HM-U2 **156**

REMACLEAN HM-U3 **158**

REMACLEAN HM-U4 **159**

REMACLEAN HM-U5 **160**

REMACLEAN HM-U6 **162**

REMACLEAN HM-U7 **163**

REMACLEAN HM-U8 **164**

REMACLEAN HM-U9 **167**

REMACLEAN HM-U10 **168**

REMACLEAN HM-U11 R **169**

REMACLEAN HM-U500 **170**

REMACLEAN INNOVATION **138**

REMACLEAN INNOVATION S **139**

REMACLEAN KWA **128**

REMACLEAN KWA PUR **130**

REMACLEAN KWA V **129**

REMACLEAN M **134**

REMACLEAN PRECISION **137**

REMACLEAN PUR **131**

REMACLEAN PUR-F3 **144**

REMACLEAN PUR-F4 **146**

REMACLEAN PUR-F4 A **148**

REMACLEAN PUR-F5 **149**

REMACLEAN PUR-F300 **150**

REMACLEAN PUR-F400 **151**

REMACLEAN PUR-F500 **152**

REMACLEAN PUR LIGHT **132**

REMACLEAN RB-IGD **180**

REMACLEAN RB-IGD V **181**

REMACLEAN RB-IGP **178**

REMACLEAN RB-IGP V **179**

REMACLEAN SGB **176**

REMACLEAN STANDARD **136**

REMACLEAN TMB **174**

REMACLEAT – Rubber cleats **196**

REMACCLIP TTB 1 **230**

REMACCLIP TTB 1 ½ **231**

REMACCLIP TTB 2 **232**

REMACCLIP TTB 2 ½ **232**

REMACCLIP TTB 2 ¾ **232**

REMACCLIP TTB 140 **231**

REMACCLIP TTB 190 **231**

REMACCLIP TTE 10 **228**

REMACCLIP TTE 12 **228**

INDEX

REMACLIP TTN 10 AS with seal	227	REMALINE 40 OIL/CN	13
REMACLIP TTN 10 S	226	REMALINE 40 ORANGE/CN	11
REMACLIP TTN 12 S	226	REMALINE 40 WHITE FOOD/CN	14
REMACLIP TTN 14 S	227	REMALINE 50/CN	16
REMACLIP TTN 16 AS with seal	227	REMALINE 60/CN	17
REMACLIP TTN 16 S	227	REMALINE 60/EP160/CN	18
REMADUST 25	184	REMALINE 65/CN	84
REMAFIX H (A+B)	66	REMALINE 70/CN	20
REMAFIX L (A+B)	66	REMALINE 70/EP160/CN	21
REMAFIX P	67	REMALINE 70 HR/CN	25
REMAFIX S	66	REMALINE 70 OIL/CN	22
REMAFLON	54	REMALINE 70 OIL/EP160/CN	23
REMAGRIP 50/CN	76	REMALINE 70 V/CN	24
REMAGRIP 60/CN	77	REMALINE 70 WHITE OIL FOOD/CN	26
REMAGRIP 60 HR/CN	80	REMALINE 90/CN	27
REMAGRIP 60 OIL/CN	79	REMALINE MP 35/CN	9
REMAGRIP 60 V/CN	78	REMALINE MP 40/CN	15
REMAGRIP 60 WHITE OIL FOOD/CN	81	REMALINE MP 60/CN	19
REMAGRIP 65/CN	82	REMALOX	38
REMAGRIP 65 V/CN	83	REMALOX HD 35	39
REMAGRIP 70/CN	85	REMALOX HD 75	40
REMAGRIP 70/CN – SL	88	REMASKIRT 40 green	108
REMAGRIP 70 HR/CN	87	REMASKIRT 50 orange	109
REMAGRIP 70 V/CN	86	REMASKIRT CB 195	110
REMAGRIP 100/CN	89	REMASKIRT CB 195 PUR	111
REMAGRIP 200 WHITE OIL FOOD/CN	90	REMASLEEVE KSB-E 60/CN	119
REMAGRIP CK-X	91	REMASLEEVE VSB-E 40/CN	118
REMAGRIP CK-X V	92	REMASLEEVE VSB-RE 25 ORANGE/CN	117
REMAGRIP CP-X	94	REMASLIDE ATEX	103
REMALEN	55	REMASLIDE plate	56
REMALINE 25/CN	6	REMASLIDE V	103
REMALINE 35/CN	7	REMASTAR/CN	28
REMALINE 35/EP160/CN	8	REMASTEEL 60	50
REMALINE 40/CN	10	REMASTEEL 70	51
REMALINE 40/EP160/CN	12	REMATHAN G 65	31

INDEX

REMATHAN G 65/CN	32	SOLVENT CF-R2	72
REMATHAN G 75	33	SOLVENT CF-R4	64
REMATHAN G 75/CN	34	Spare and wear parts – REMACLEAN HM-F1	140
REMATHAN G 90	35	Spare and wear parts – REMACLEAN HM-F2 / HM-F2 HR	142
REMATHAN G 90/CN	36	Spare and wear parts – REMACLEAN HM-F2 VA	143
Repair fabric	214	Spare and wear parts – REMACLEAN HMT-U1 S, HM-U9, HM-U10	168
Repair fabric EP 100	205	Spare and wear parts – REMACLEAN HM-U1	154
Repair strip	209	Spare and wear parts – REMACLEAN HM-U1 HR	155
Repair strip EP 160, fabric reinforced	210	Spare and wear parts – REMACLEAN HM-U1 VA	155
Repair strip EP 160 V, fabric reinforced	210	Spare and wear parts – REMACLEAN HM-U2	157
Repair strip V	209	Spare and wear parts – REMACLEAN HM-U3	161
Reversing stop HM-U3 / HM-U5 / INNOVATION	138	Spare and wear parts – REMACLEAN HM-U4 / HM-U5	161
Reversing stop HM-U3 / HM-U5 / INNOVATION	161	Spare and wear parts – REMACLEAN HM-U6	162
Rhomboid patches	207	Spare and wear parts – REMACLEAN HM-U7 / HM-U8	165
Rhomboid patches EP 160, fabric reinforced	207	Spare and wear parts – REMACLEAN HM-U11 R	169
Round patches	207	Spare and wear parts – REMACLEAN HM-U500	170
Rubber bristle GRB	172	Spare and wear parts – REMACLEAN INNOVATION S	139
Rubber sheeting	206	Spare and wear parts – REMACLEAN PUR-F3	145
Rubber sheeting V	206	Spare and wear parts – REMACLEAN PUR-F4	147
		Spare and wear parts – REMACLEAN PUR-F5	149
		Spare and wear parts – REMACLEAN PUR-F300	150
		Spare and wear parts – REMACLEAN PUR-F400	151
		Spare and wear parts – REMACLEAN PUR-F500	152
		Spare and wear parts – REMACLEAN TMB	175
		Spare and wear parts – REMASKIRT CB 195	110
		Spare cleaning brush GRB	172
		Spare cleaning brush SGB	177
		STZ extruder	218
S		T	
Screw clamps TS	229	T2 products	69
Serrated profile plate ZP A	44	Template TL-B	233
Serrated profile plate ZP B	44	Tschan coupling GRB	173
Serrated profile plate ZPL	45	TT clamping profiles	185
Shaft set GRB	173		
Shark tooth clips TT-R	235		
Socket wrench	234		
SOLUTION HCR-4	215		
SOLUTION HL-T	73		
SOLUTION HL-T4	214		
SOLUTION HL-WK4	223		
SOLUTION STL-RF	73		
SOLUTION STL-RF4	218		
SOLVENT CF-CE	64		

INDEX

TT-Fastening Units I	43
TT-Fastening Units I	104
TT-Fastening Units II	43
TT-Fastening Units III	43
TT-Fastening Units IV	104

U

UNIGRIP 60/KS	96
UNIGRIP 65/KS	97
UNILAG/KS	98
UNILINE 40/KS	29
UNILINE 60/KS	30
UNISKIRT 40 black	112
UNISKIRT 40 red	113
UNISKIRT 60 black	114
UNISLIDE	105
UVZ plate	46

W

Wave stop system	229
WK cover rubber (cover stock)	223
WK intermediate rubber (tie gum)	222
Wrench	233

Z

ZP bars	42
---------	-----------



Your local contact



// ONE BRAND // ONE SOURCE // ONE SYSTEM

- // SERVICE
- // MATERIAL PROCESSING
- // SURFACE PROTECTION
- // AUTOMOTIVE

REMA TIP TOP AG
Gruber Strasse 65 · 85586 Poing / Germany
Phone: +49 8121 707-0
Fax: +49 8121 707-10 222
info@tiptop.de
www.rema-tiptop.com



582 0201 - III 16 Printed in Germany

